

# EVGA | Intelligent Innovation

## EVGA nForce 730i Visual Guide

The following quick steps will guide you through testing the absolute bare minimum essentials of your motherboard before installing it into a system chassis. Visual aids are provided to assist you during the following procedures.

To reduce the risk of fire, electric shock, and injury always follow basic safety precautions. It is recommended that you use electrostatic discharge (ESD) countermeasures such as an ESD wrist strap or anti-static mat when handling computer components.

After removing the EVGA nForce 730i from its packaging, place it on to a nonconductive surface. For example: wood, cardboard box, or an anti-static mat.

**1**

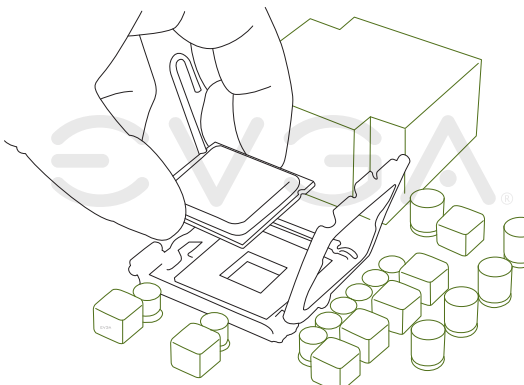
a. 

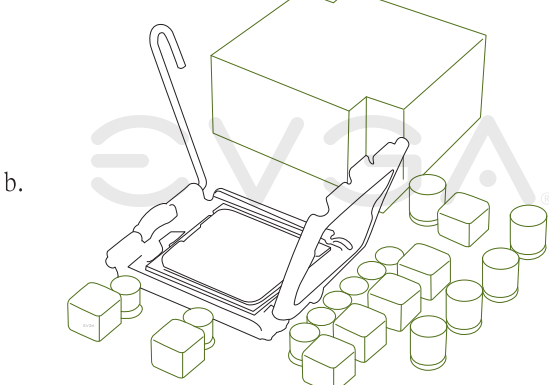
b. 

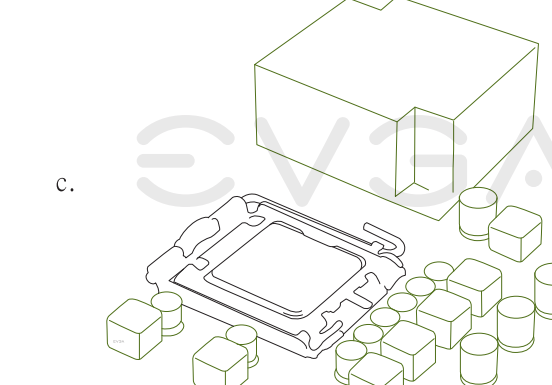
c. 

Unhook the socket lever and lift up the load plate. Remove the LGA 775 protective cover and carefully install your Intel processor making sure to properly align the notches. Close the load plate and with light pressure, lower the socket lever back in to its original position.

**2**

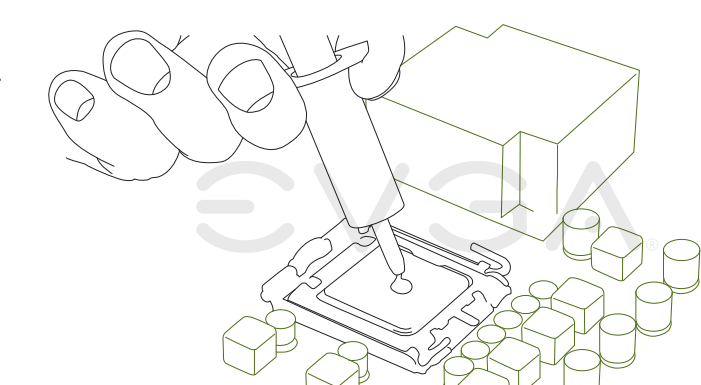
a. 

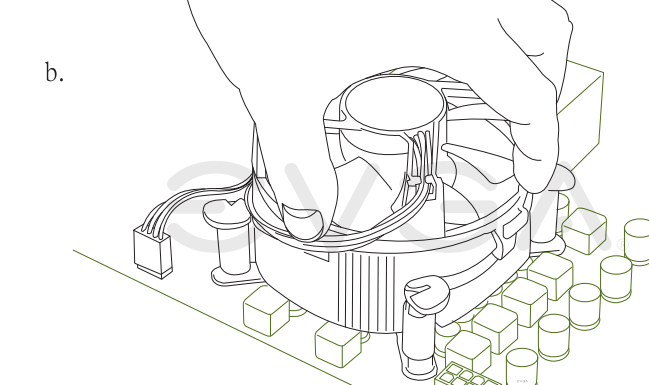
b. 

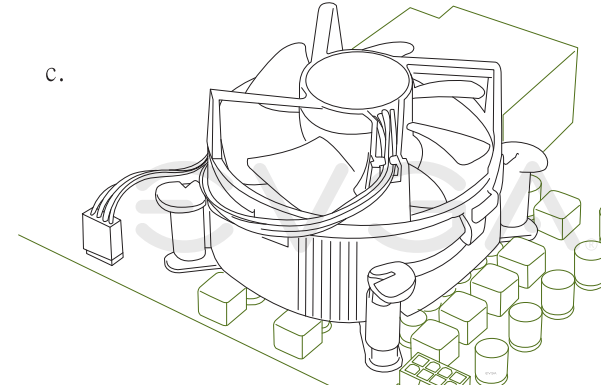
c. 

Apply a small, pea-sized drop of thermal paste on to the middle of the processor. Install your processor heatsink and fan.

**3**

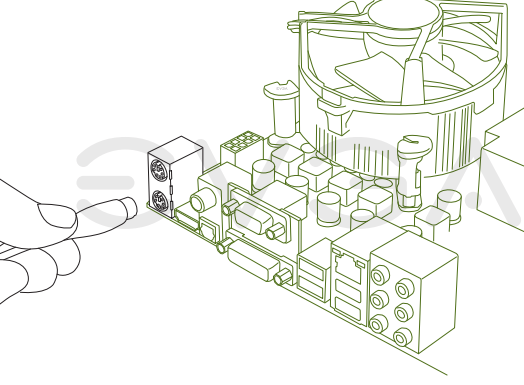
a. 

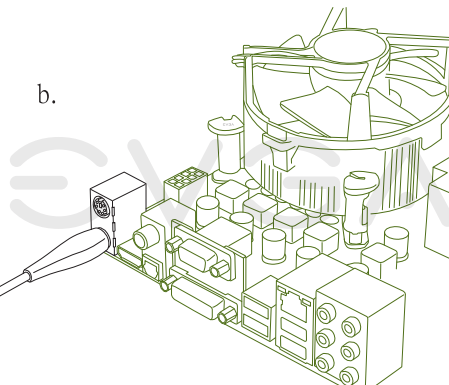
b. 

Plug in one keyboard into a USB port or PS/2 port.

**4**

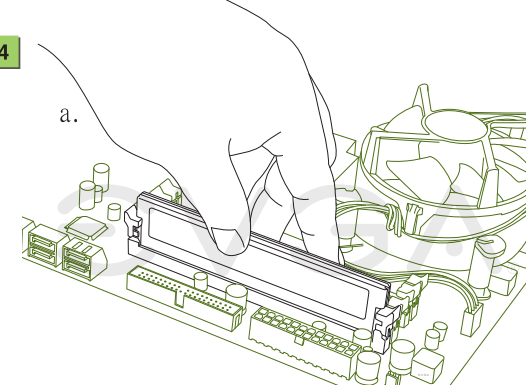
a. 

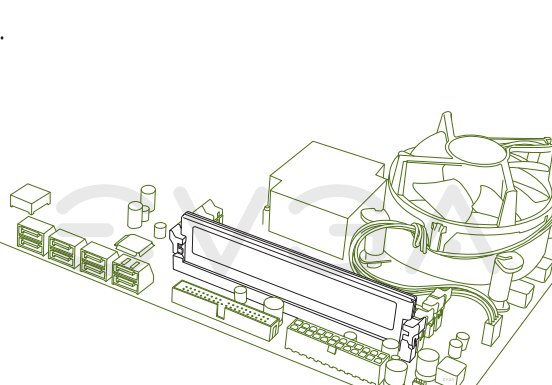
b. 

Install one stick of system memory (DIMM) in to the DIMM slot of your choice.

**5**

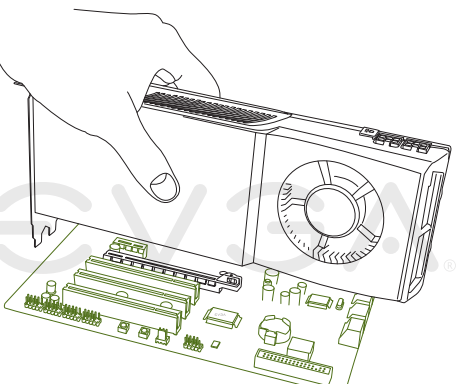
a. 

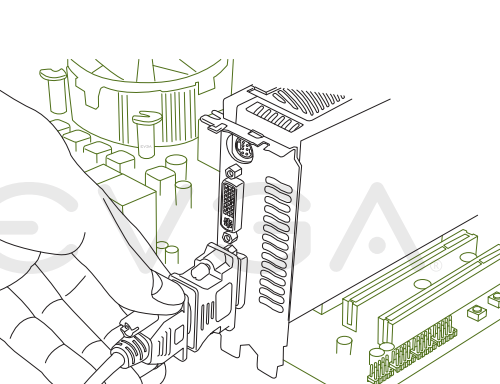
b. 

Insert your graphics card into either the PCI-E 2.0 slot or the PCI slot. The type of slot depends on the graphic card bus type. Connect a monitor to the output connector of the graphics card.

**6**

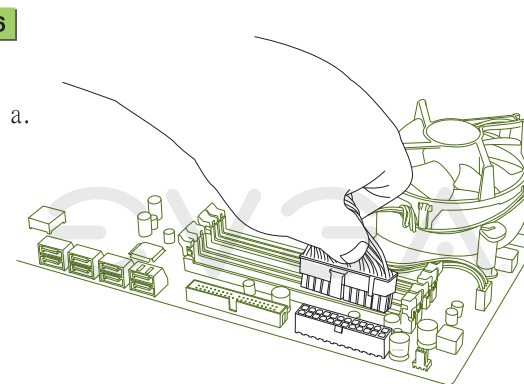
a. 

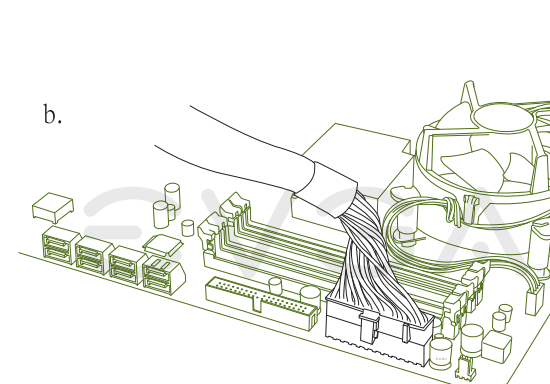
b. 

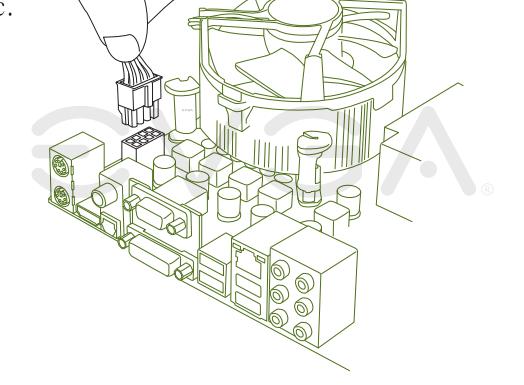
c. 

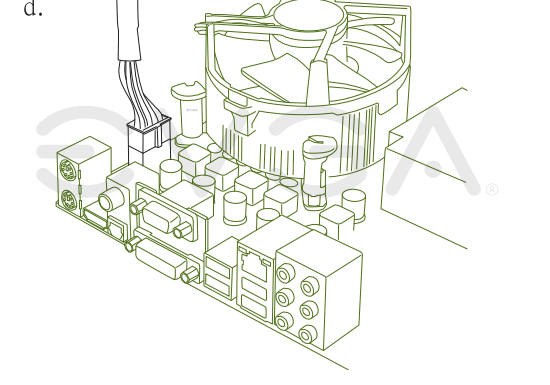
d. 

Make sure your power supply's power switch is in the OFF position then connect your 24-Pin ATX Power Connector and 8-Pin CPU Power Connector to the motherboard.

**7**

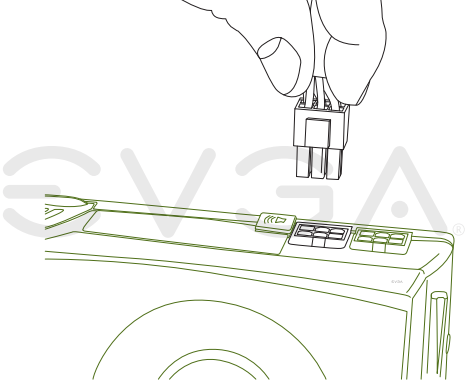
a. 

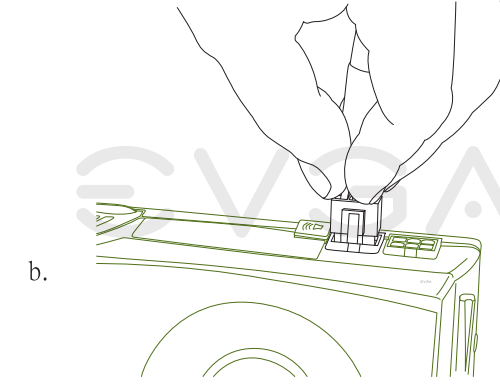
b. 

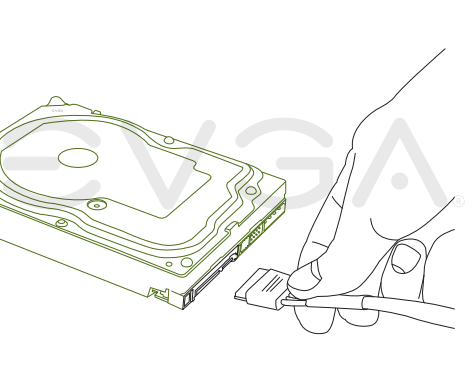
c. 

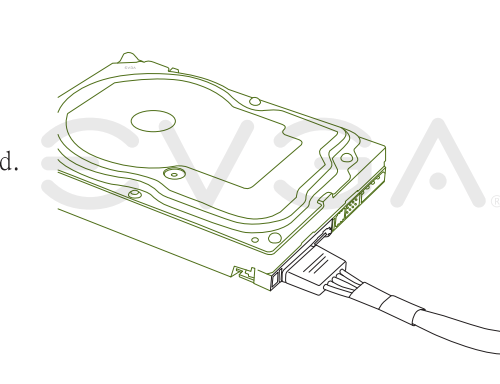
d. 

Plug in power connectors to both the graphics card and the hard disk drive. Power connector types will vary depending on the hard disk drive and graphic card's power requirements.

**8**

**SATA Connection**

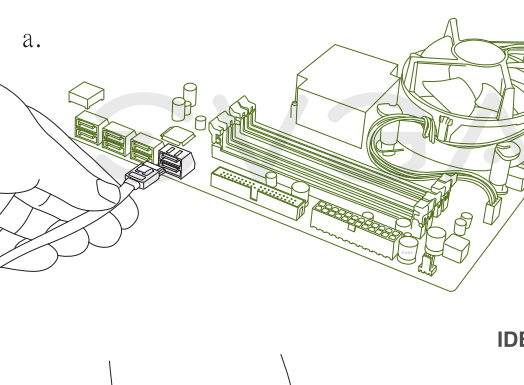
a. 

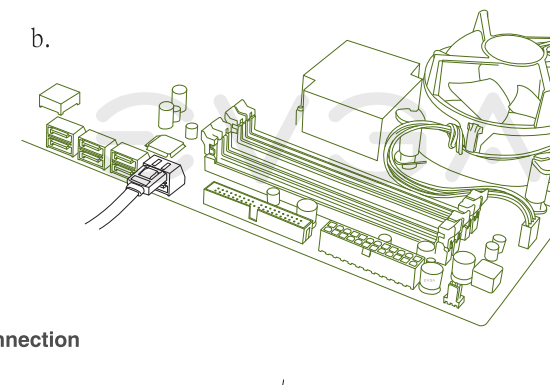
b. 

**IDE Connection**

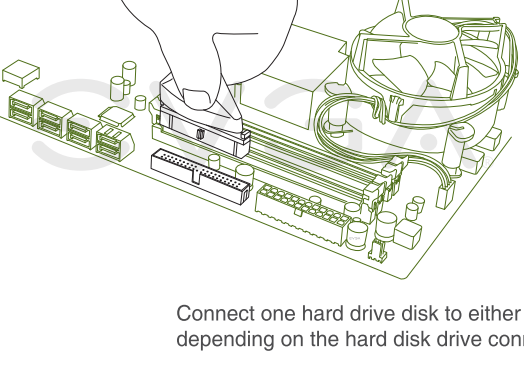
c. 

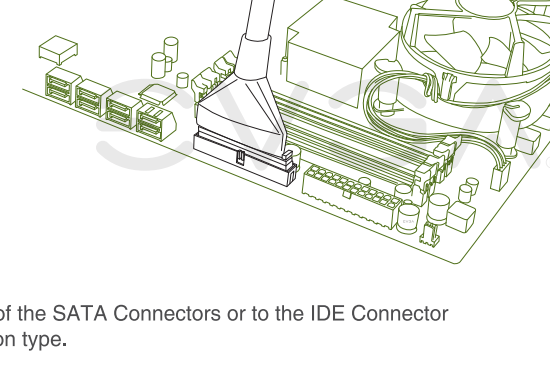
d. 

Connect one hard drive disk to either one of the SATA Connectors or to the IDE Connector depending on the hard disk drive connection type.

**9**

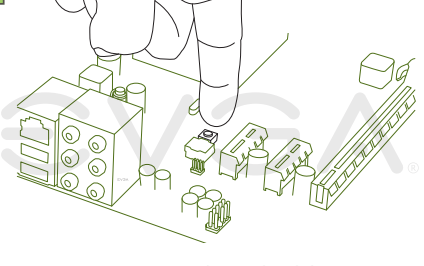
a. 

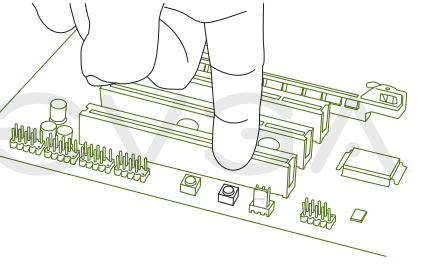
b. 

On the power supply, flip the power switch to the ON position. LEDs will now be lit on the motherboard. Press the onboard Clear CMOS button once then press the red Power Button to begin powering up the system.

At this final stage, you should now be greeted with the POST screen on your monitor.



## EVGA nForce 730i Quick Install Guide

Please see the manual for more details

### Install the CPU

1. Unlock the socket by pressing the lever sideways, then lift it up to a 90° angle.
2. Lift the load plate. There is a protective socket cover on the load plate to protect the socket when there is no CPU installed.
3. Remove the protective socket cover from the load plate. (Save this protective piece, as it is needed whenever transporting or shipping the motherboard.)
4. Align the notches in the CPU with the notches on the socket.
5. Lower the CPU straight into the socket. Close the lid plate and engage the socket lever.
6. The CPU will need a proper cooling solution, please refer to the manual that came with your heatsink for detailed instructions.



### Install System Memory (DIMMs)

1. This motherboard supports up to four 240-pin DDR2 memory modules. Having matched pairs is highly recommended for dual channel configurations.
2. For dual channel configurations use DIMM slots 1 and 2, 3 and 4, or 1 through 4. It is recommended to use the "Black Slots" if running in 2 Dimm Mode

\* Use matching color slots for dual channel

### Install Graphics Card

1. This motherboard has one PCI Express X16 slot for a discrete graphics card or you can choose to use the onboard graphics processor for video output.

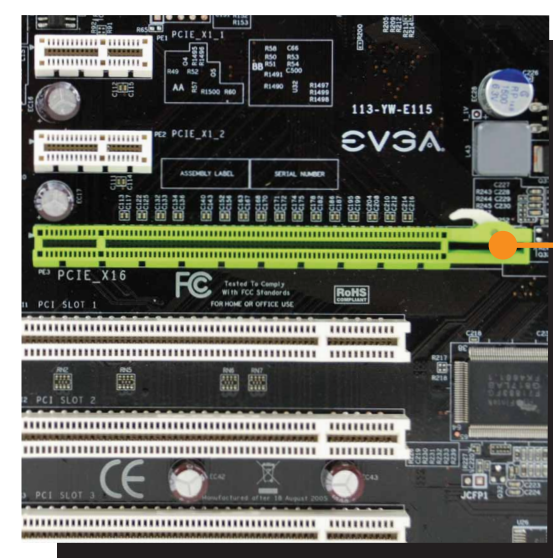

PCI Express X16 slot

### Connect Peripherals

1. Connect your peripheral devices such as hard drives, floppy drive, and DVD-ROM drives to the motherboard.

#### Cables



Floppy



IDE



SATA

For package information and more details, please visit the manual.

2. Connect power cables to the motherboard and any other peripherals in your system.
- \* Remember to plug in your PCI-E power cables to your graphics card(s) if necessary.
3. Connect the front panel headers and any other headers that are going to be in use.

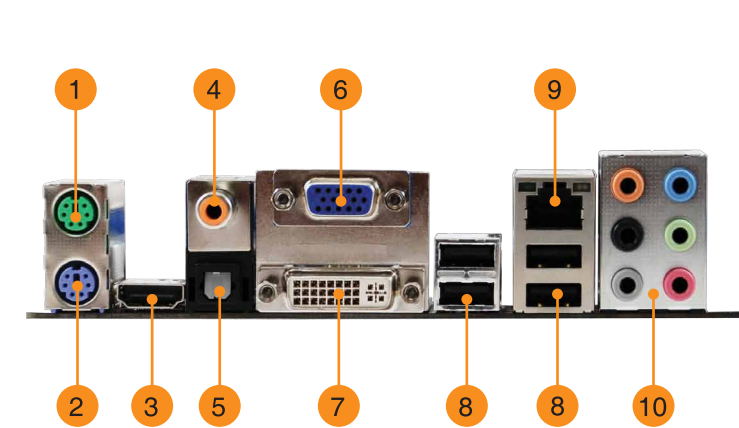

- |                         |                  |
|-------------------------|------------------|
| 1. PS/2 Mouse Port      | 6. VGA Port      |
| 2. PS/2 Keyboard Port   | 7. DVI-D Port    |
| 3. HDMI Port            | 8. USB 2.0 Ports |
| 4. Coaxial SPDIF output | 9. LAN Port      |
| 5. Optical SPDIF output | 10. Audio Port   |

Connector	Pin	Signal
Front Audio Connector	1	PORT1_L
	2	AUD_GND
	3	PORT1_R
	4	PRESENCE_J
	5	PORT2_R
	6	SENSE1_RETURN
	7	SENSE_SEND
	8	Empty
	9	PORT2_L
	10	SENSE2_RETURN

Connector	Pin	Definition
SPDIF	1	Power
	2	No Pin
	3	SPDIF
	4	SPDIF
	5	GROUND
	6	GROUND

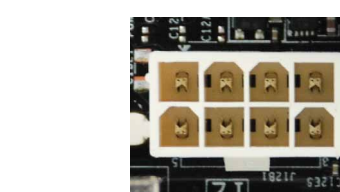

8 pin 12v power

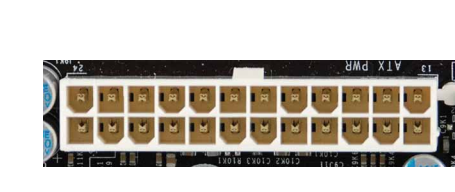

24 pin ATX power

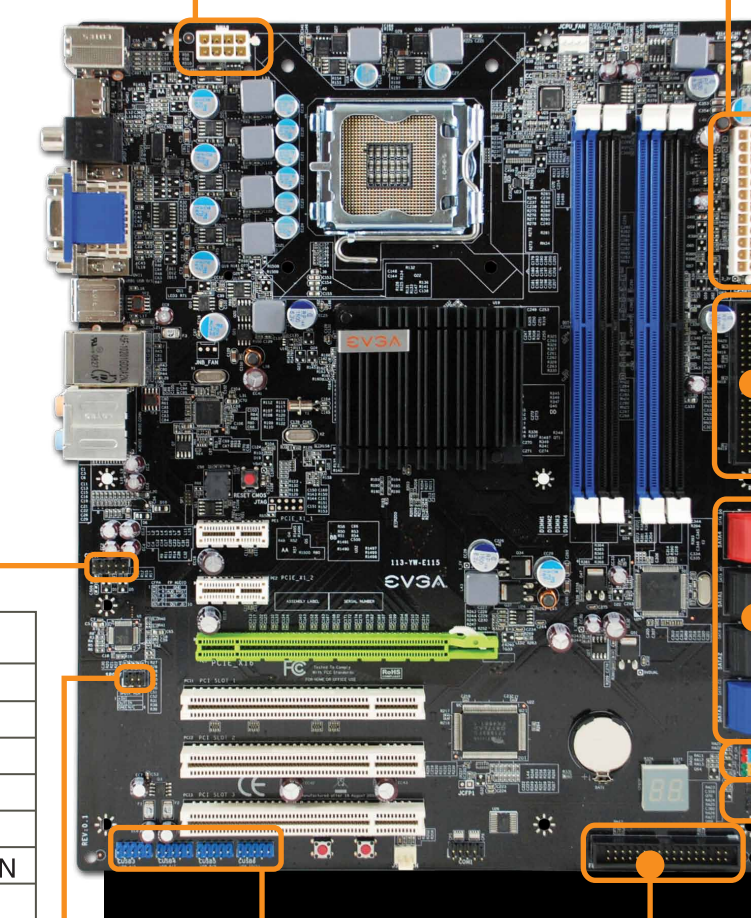

IDE Channel

SATA ports

Floppy Channel

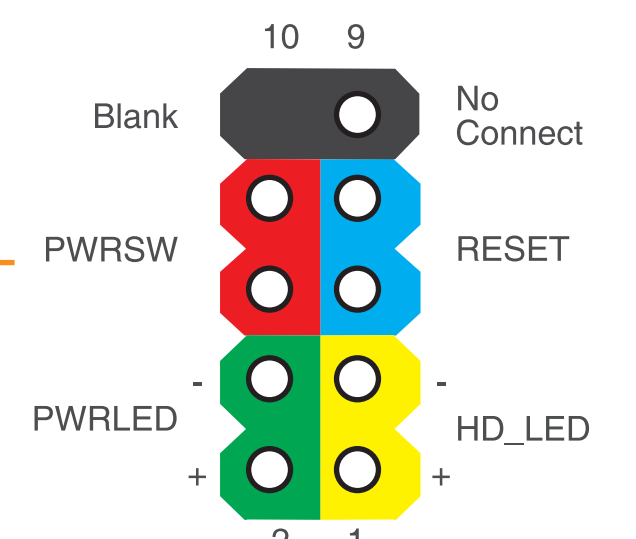

Connector	Pin	Signal
Speaker Header	1	VCC
	2	Empty
	3	GND
	4	Speaker