

EVGA | Intelligent Innovation

INTERVIEW™

Dual Monitor System



Manual

TABLE of CONTENTS

- 1. PRODUCT OVERVIEW.....4**
 - 1.1 What’s Included..... 4
 - 1.2 Safety Instructions 5
 - 1.3 Product Views 6
- 2. INTERVIEW SPECIFICATIONS.....9**
 - 2.1 InterView Technical Specifications 9
 - 2.2 Preset Timing Modes 10
 - 2.3 Power Management Modes..... 10
- 3. SETTING UP INTERVIEW11**
 - 3.1 Steps to Assembling InterView 11
 - 3.2 Connecting InterView to a PC 13
 - 3.3 Plug and Play Compatibility 15
- 4. HOW TO ADJUST INTERVIEW16**
 - 4.1 Rotating/Folding 16
 - 4.2 Control Buttons..... 17
 - 4.3 Brightness Adjustment 17
 - 4.4 Auto Adjustment..... 17
- 5. SYSTEM REQUIREMENTS AND SOFTWARE INSTALLATION.....18**
 - 5.1 System Requirements..... 18
 - 5.2 Installing the Webcam Software..... 18
 - 5.3 Using the InterView Camera Application 22
- 6. TROUBLESHOOTING.....27**
 - 6.1 Self-Test Feature Check 27
 - 6.2 FAQs 27
- 7. SERVICE INFORMATION30**
 - 7.1 Product Registration and Customer Support..... 30
 - 7.2 Pixel Policy..... 30

7.3 Warranty Terms and Conditions 31

8. COMPLIANCE INFORMATION 33

8.1 FCC Notice 33

9. LEGAL INFORMATION 34

9.1 Trademark Information 34

9.2 Software License Agreement 34

9.3 Rights 34

1. PRODUCT OVERVIEW

1.1 What's Included

The following items are included with InterView:

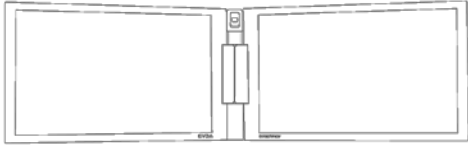

InterView Monitor:
Dual – 17 Inch – LCD Panels

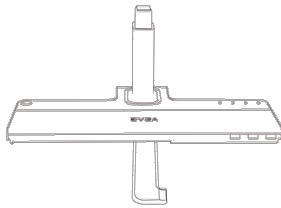

InterView Multiplatform Control Base

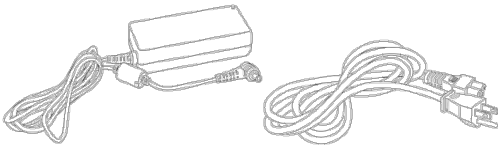

AC Power Adapter
Power Cord

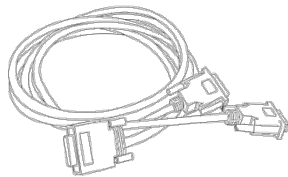

DMS to DUAL DVI-I Signal Cable

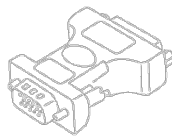

DVI-I to VGA Adapter

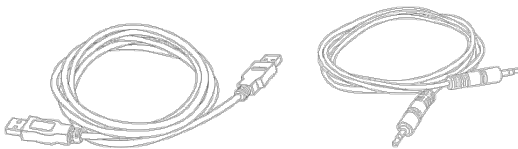

Microphone Audio Cable
USB Cable



Visual Guide
Drivers and Software CD

1.2 Safety Instructions

Safe Environment



Do not store or use the InterView in locations that are exposed to heat, extreme cold, high humidity or dusty environment. Room temperature conditions are recommended.



Do not subject InterView to severe vibrations or high impact conditions.



Do not allow water or other liquids to spill on or into InterView.



InterView may become unstable if not placed on a solid and horizontal surface.

Safe Use



To avoid electric shock, never touch the components inside of InterView. Only a qualified technician should open the monitor case.



Do not try to insert anything metallic or push objects into any openings.



Do not use benzene, thinner, ammonia, abrasive cleaners, or compressed air as these will cause damage to the LCD screens. If possible, use a special screen-cleaning tissue or solution suitable for the anti-static coating.



Handle your monitor with care as darker-colored plastics may scratch and show scuff marks.



Keep hands off the gap between the stand and the panel as injury may take place while rotating or folding the LCD portion of InterView.



Unplug the monitor when it is going to be left unused for an extended period of time or before any type of service is performed.



Consider keeping the packaging for use in the future when you may need to transport the monitor. The fitted foam packing is ideal for protecting the monitor during transport.

1.3 Product Views

Panel Front View

1. Integrated Webcam
2. Balance Bar
3. Multiplatform Control Base
4. Integrated 3-Port USB 2.0 Hub
5. 17 Inch LCD Panels

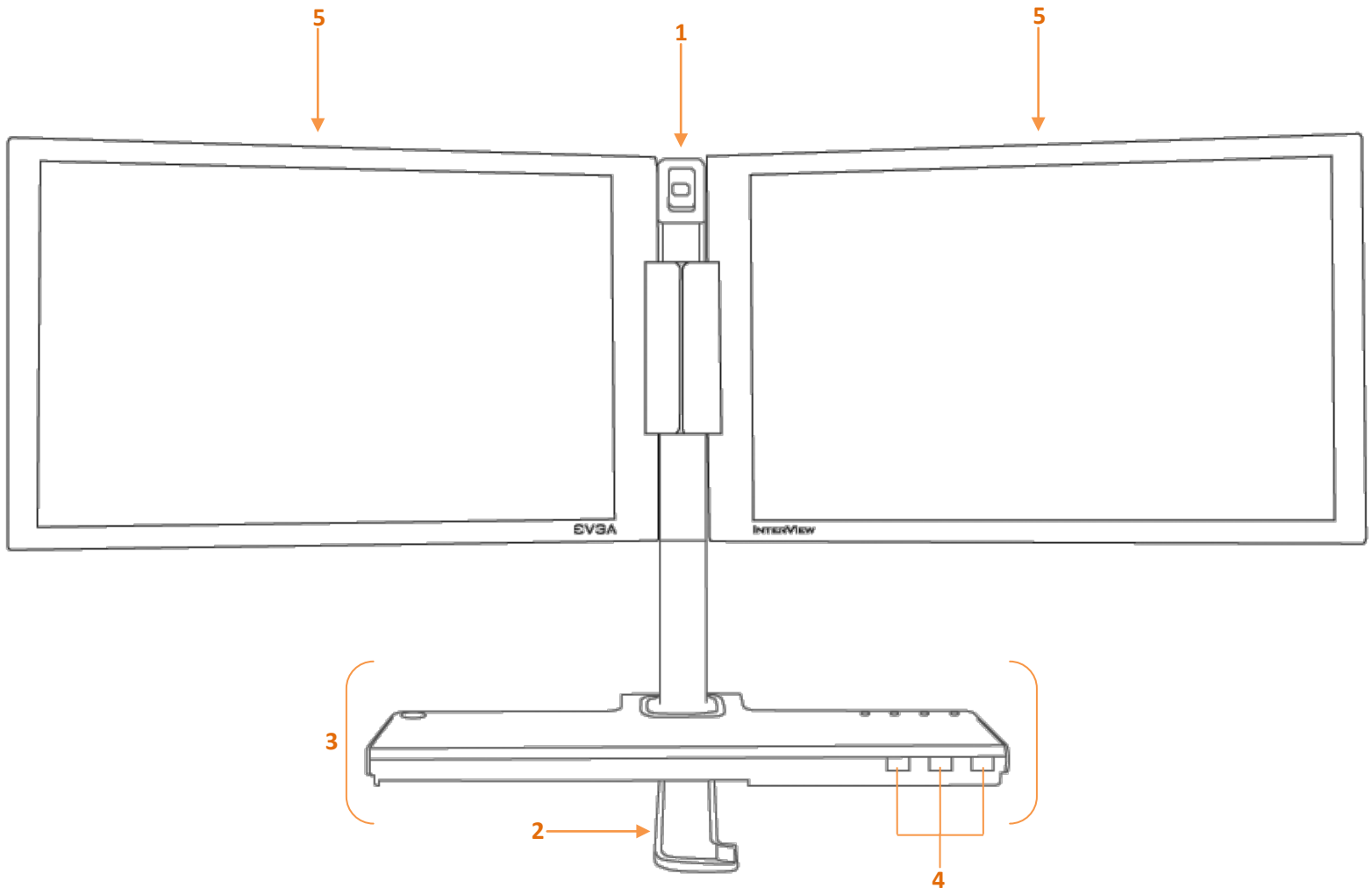

Control Base Front View

1. Power Button
2. Power Light Indicator (Left Panel)
3. Power Light Indicator (Right Panel)
4. Panel Selection Button
5. Brightness Adjust (Down)
6. Brightness Adjust (Up)
7. Auto Adjust
8. Integrated Microphone

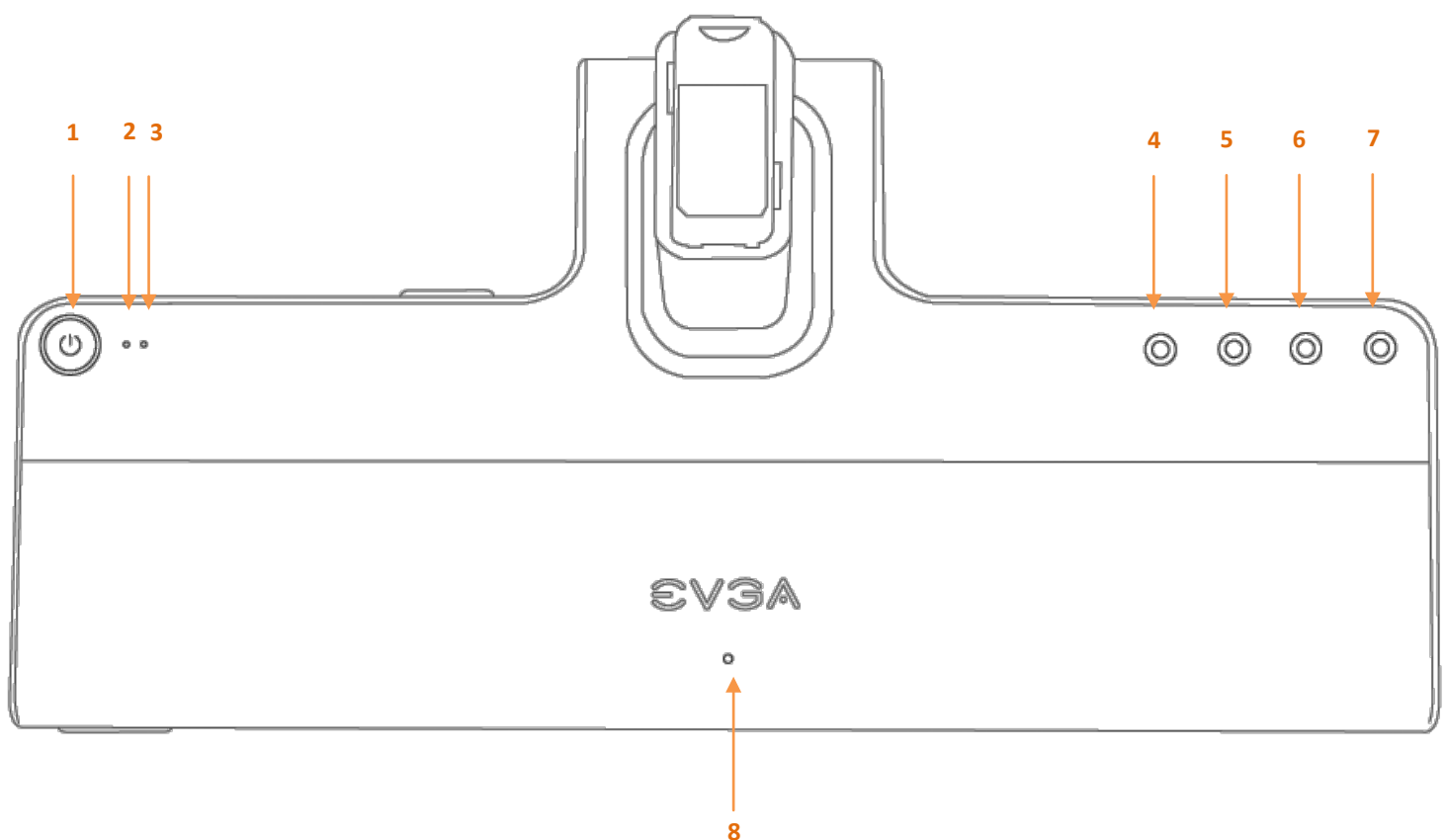

Control Base Back View

1. USB to PC Port
2. Microphone Jack
3. DMS Port
4. AC Power Connector

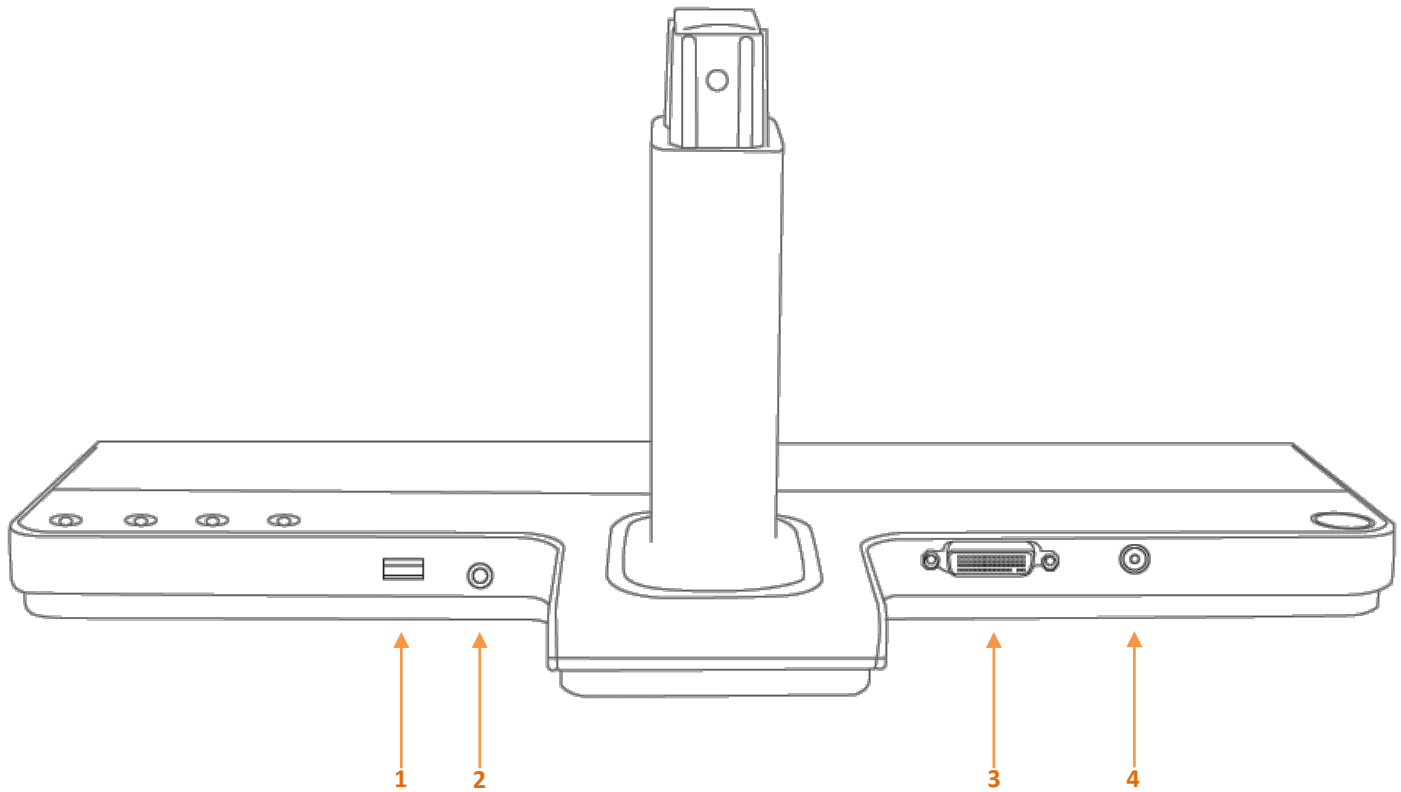

2. INTERVIEW SPECIFICATIONS

2.1 InterView Technical Specifications

General

Model number EVGA InterView 1700

LCD

Screen type 17" Wide TFT

Preset display area

Horizontal 367.20 mm
Vertical 229.50 mm

Synchronization

Horizontal 31.5 kHz to 81.1 kHz
Vertical 56 Hz to 76 Hz

Viewing angle

Horizontal 20° / 35° (CR=10)
Vertical 45° / 45° (CR=10)
Pixel pitch 0.255 X 0.255 mm
White luminance 220 typ.
Contrast ratio 500:1 typ.
Response Time 8ms typ. (14ms typ. max)

Resolution

Optimal preset resolution 1440x900*2 @ 60 Hz

Highest preset resolution 1440x900*2 @ 60 Hz

Physical Characteristics

Dimensions

Bezel Closing Dimension 417 x 485 x 390 mm
Bezel Opening Dimension 369 x 188 x 870 mm

Weight 7.5 kg/16.52 lbs

Environmental

Operating

Temperature 5° to 35°C
Humidity 30% to 80% (non-condensing)

Non-operating

Temperature -10° to 60°C
Humidity 10% to 85% (non-condensing)

2.2 Preset Timing Modes

The screen will be adjusted automatically when the signal transferred from the computer is the same as the following Preset Timing Modes. If your display mode is not listed, it is not supported by this monitor; the screen may go blank while the power LED is on.

Display Mode	Horizontal Frequency (kHz)	Vertical Frequency (Hz)	Pixel Clock (MHz)	Sync Polarity (Horizontal/Vertical)
VESA, 640x480	31.469	59.940	25.175	-/-
VESA, 640x480	37.500	75	31.500	-/-
VESA, 800x600	37.879	60.317	40.000	+/+
VESA, 800x600	45.072	72	46.875	+/+
VESA, 800x600	46.875	75	49.500	+/+
VESA, 1024x768	48.363	60.004	65.000	-/-
VESA, 1024x768	60.023	75.029	78.750	+/+
VESA, 1152x864	67.500	75.000	108.000	+/+
VESA, 1280x1024	63.981	60.020	108.000	+/+
VESA, 1280x1024	79.976	75.025	135.000	+/+
VESA, 1440x900	55.935	59.887	106.500	-/+
VESA, 1440x900	70.635	74.984	136.750	-/+

2.3 Power Management Modes

For energy conservation, InterView has built-in power management that saves energy by switching itself to low-power mode when it has not been used for a certain amount of time. It automatically returns to normal operation when the users press a key on the keyboard. It is recommended to turn InterView OFF when it is not needed or when leaving it unattended for long periods of time.

VESA Modes	Horizontal Sync	Vertical Sync	Video	Power Indicator
Normal operation	Active	Active	Active	Blue
Active-off mode	Inactive	Inactive	Blanked	Amber
Switch off	n/a	n/a	n/a	Off

3. SETTING UP INTERVIEW

 Read the safety instructions before setting up the InterView.

3.1 Steps to Assembling InterView

1. Rotate the balance bar out from the bottom of the base:

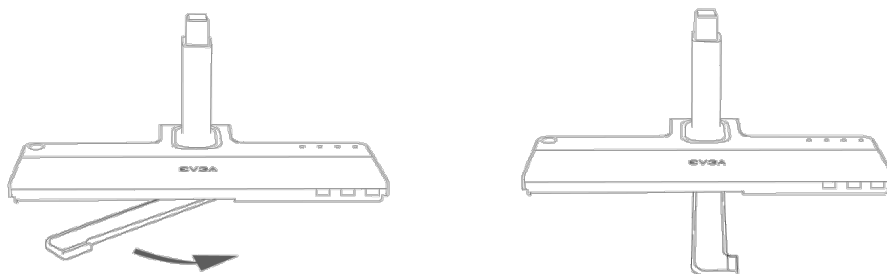

2. Remove the caps on the stand and the panel:

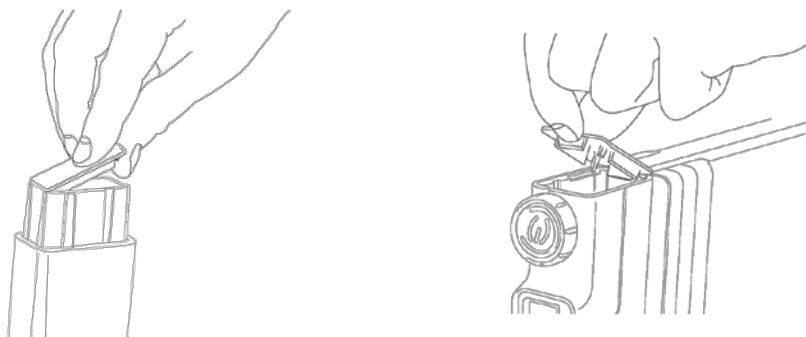

3. Assemble the stand and the panel:

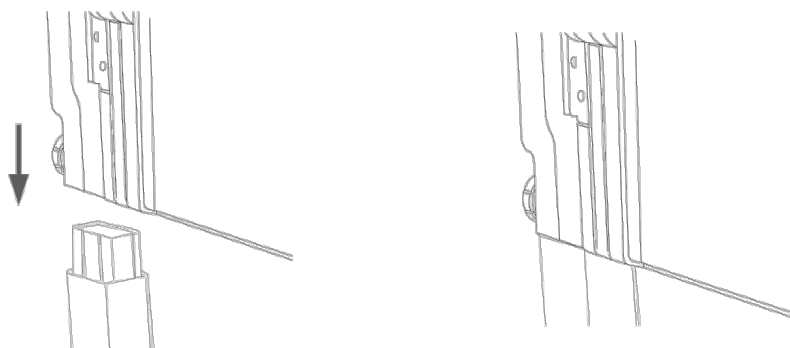

4. Push in the button and turn it clockwise to lock up the stand and the panel:

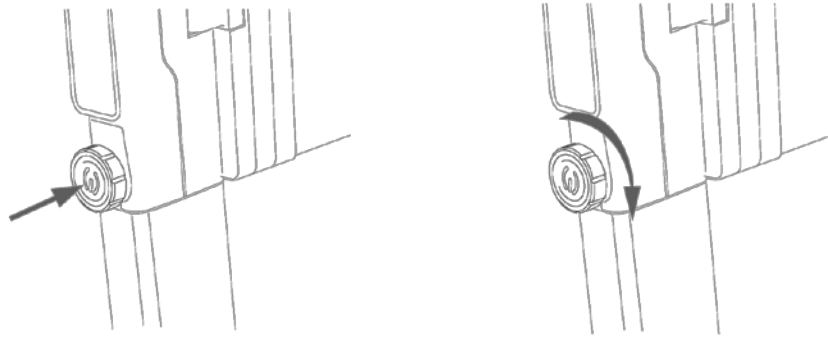

5. Open up the panel:

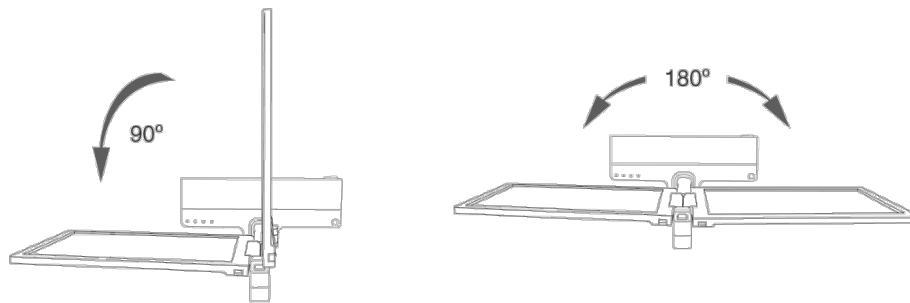

6. Push the balance bar back into the base:

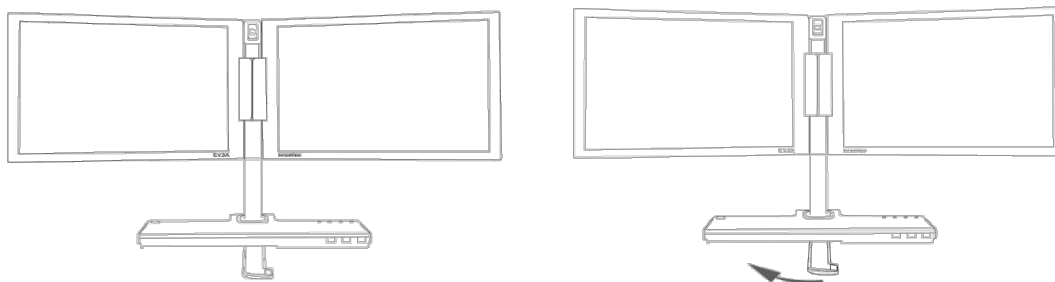

3.2 Connecting InterView to a PC

 Before setting up InterView, you must power down your computer(s).

1. Connect the monitor to a computer(s) using the DMS to Dual DVI-I cord.
Note: You can use either the D-Sub plug or the DVI-D plug if there's no available DVI-I port on your PC.

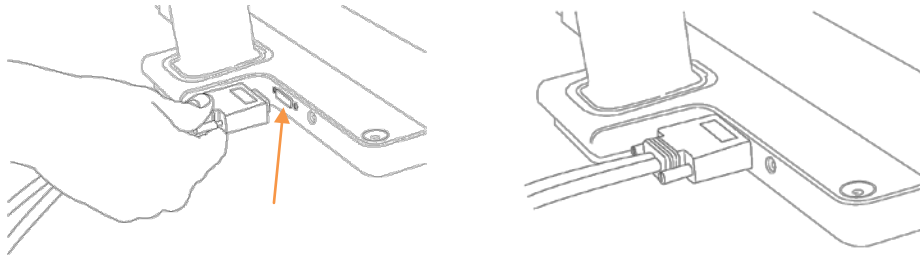

2. Plug the power cord into the power adapter:

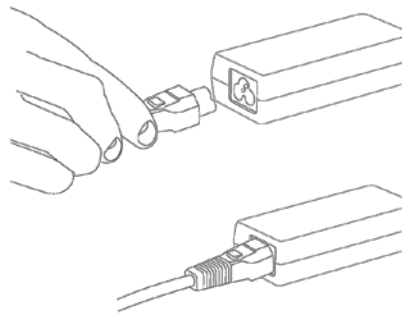

3. Connect the monitor to the electrical outlet using the power cord:

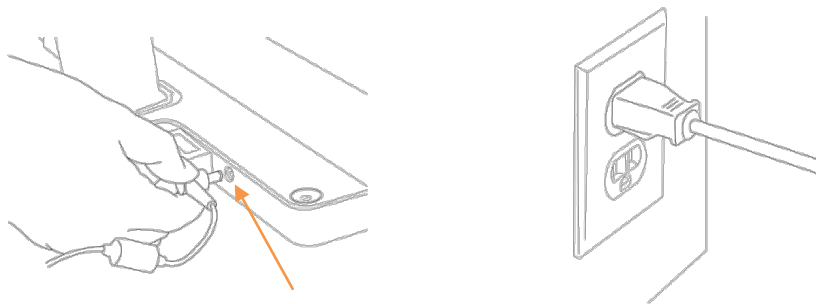

4. Power on InterView and the computer(s):

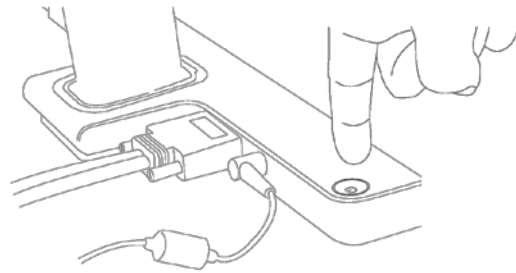

5. Use the audio cable to connect InterView to the MIC or Line-in input of the computer. This is required to use the onboard microphone.

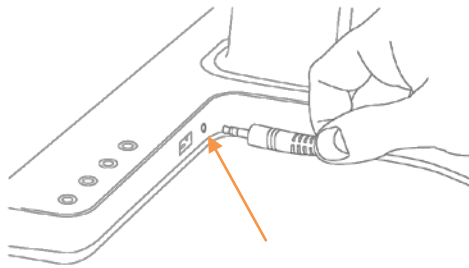

6. Connect InterView to the computer(s) with the USB cable to enable the front USB 2.0 HUB located on the monitor base. This is also required to use the onboard webcam.

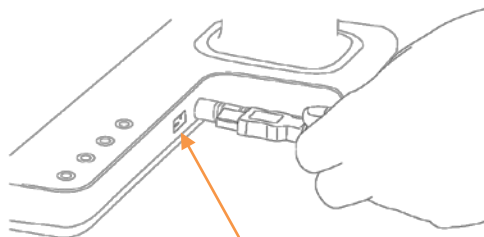

3.3 Plug and Play Compatibility

You can use InterView with any Plug and Play compatible system. The system configures itself and optimizes the display's settings. In most cases, InterView's installation is automatically processed unless the user intervenes.

4. HOW TO ADJUST INTERVIEW

4.1 Rotating/Folding

Each panel can rotate 180 degrees. The display will automatically adjust to the correct position.

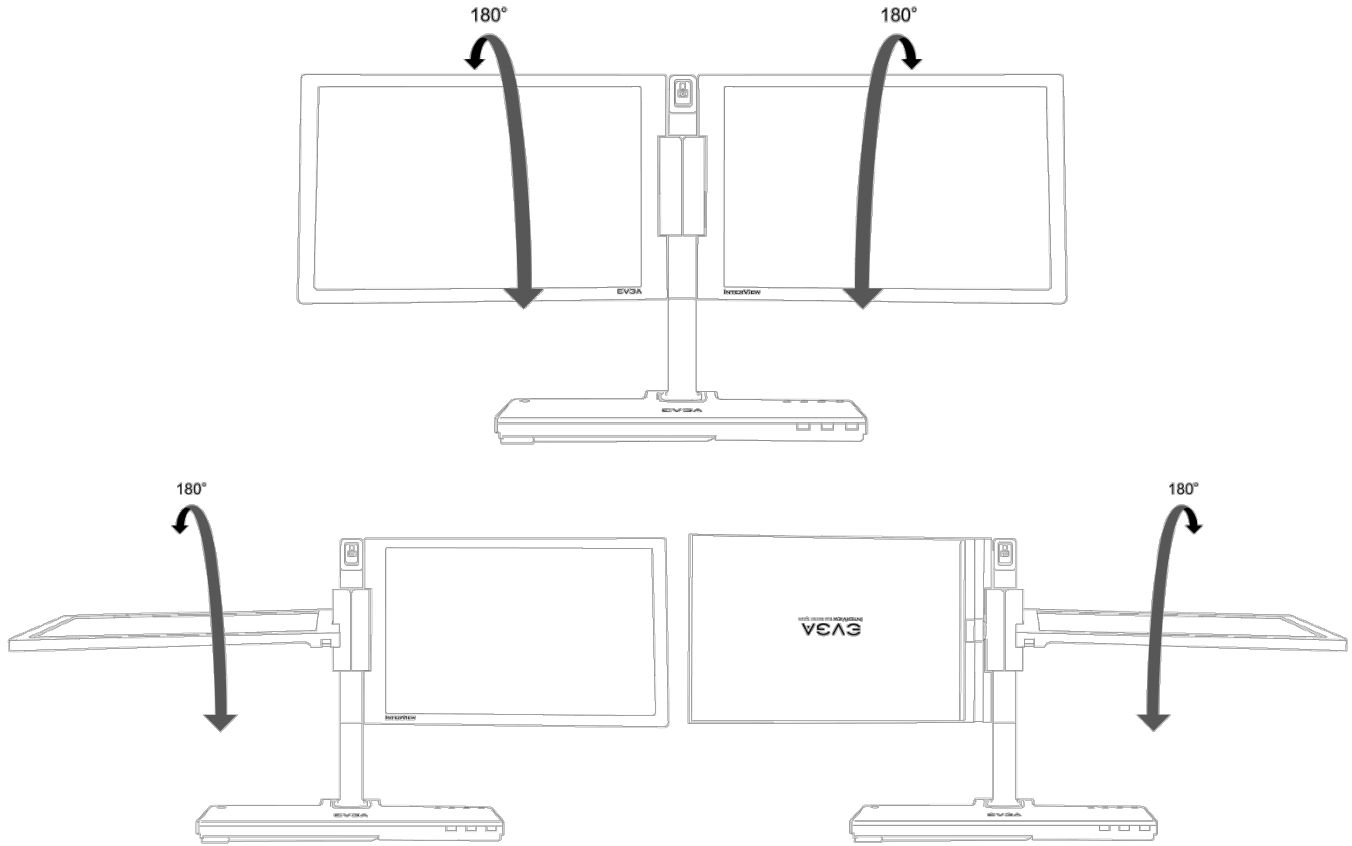

Each panel can be opened and closed 90 degrees horizontally.

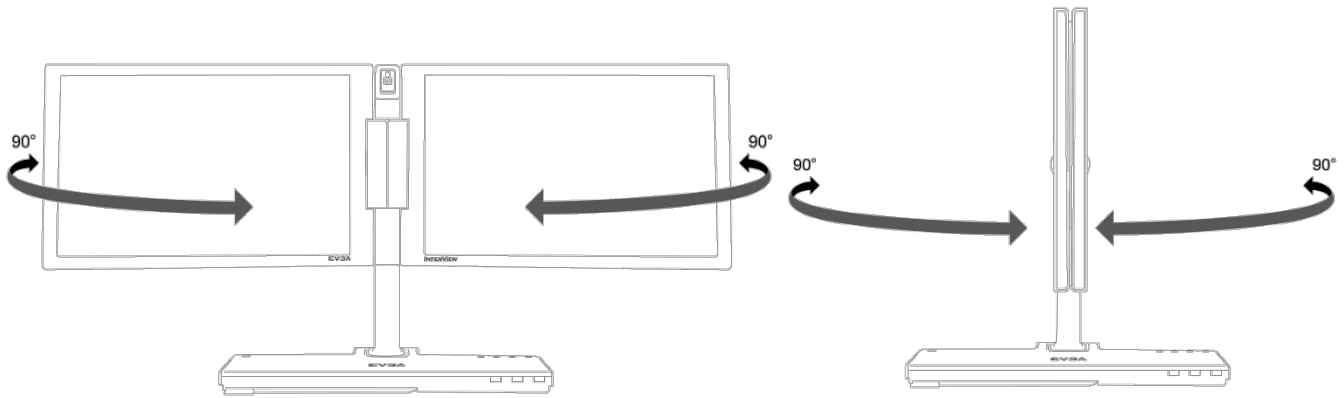

4.2 Control Buttons

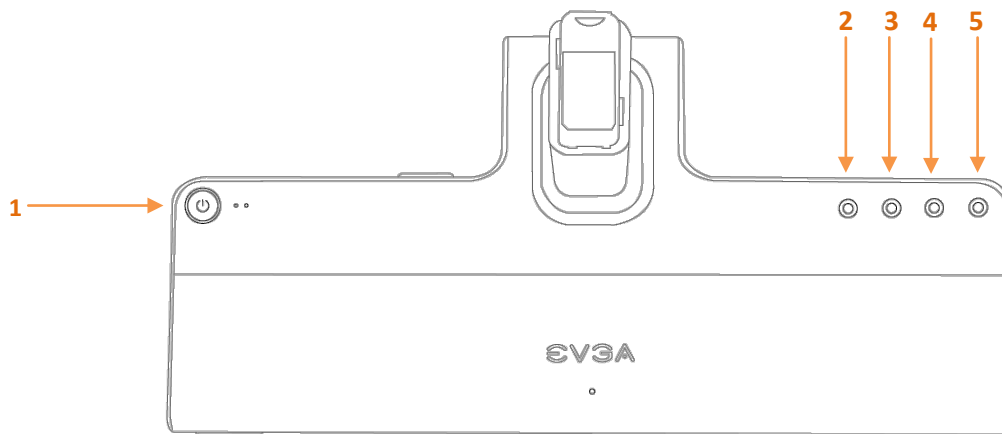

1. Power Button: Powers the InterView ON or OFF
2. Panel Selection Button: Selects the monitor to be adjusted
3. Brightness Adjust (Down): Decreases brightness levels
4. Brightness Adjust (Up): Increases brightness levels
5. Auto Adjust: Adjusts vertical position, phase, horizontal position, and pixel clock automatically

4.3 Brightness Adjustment

Users can adjust the monitor brightness levels from the Brightness (Up/Down) buttons. The Brightness levels can be adjusted from level 0 to level 8 and will be displayed on the screen while adjusting. Press the Panel Selection Button to select the panel to be adjusted.

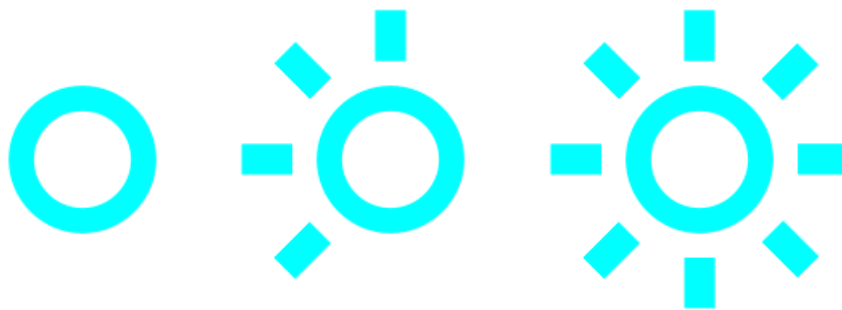

4.4 Auto Adjustment

Users can obtain an optimal display when using the AUTO key function. When the 'AUTO' button is pressed, InterView will optimize the currently selected panel.

 Auto Adjustment is disabled when using a DVI connection or DVI dongle.

5. SYSTEM REQUIREMENTS AND SOFTWARE INSTALLATION

5.1 System Requirements

Operating Systems Supported:

- Windows XP Home Edition
- Windows XP Professional
- Windows XP Professional X64 Edition
- Windows Vista™
- Windows Vista™ 64-bit

Hardware:

- 64MB of System Memory or more
- 50MB Hard Disk space or more

Others:

- Microsoft DirectX 9.0C

5.2 Installing the Webcam Software

 Some functions provided in InterView Application may not work if the driver is not installed properly

(Step 1) Before the Installation

- View the Device Manager to check if the InterView webcam has already installed. Select Start → (XP)Run or (Vista)Search Box → type *devmgmt.msc* → Click OK. The Device Manager window will appear. Expand "Imaging Devices" to reveal the device name: *USB2.0 UVC PC Camera*.

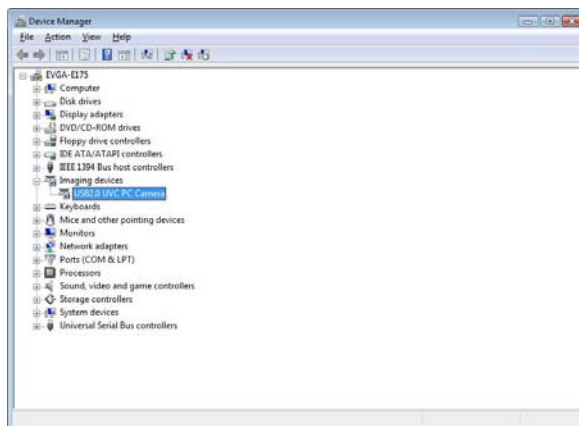

- Insert the InterView CD into the disc drive. The AutoPlay dialogue box will appear.
- Click Run autorun.exe

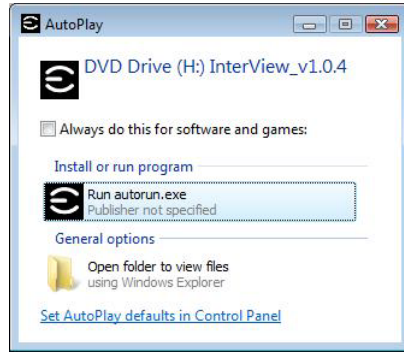

(Step 2) Processing Installation

- Click *Webcam software installation* to start the installation process



- Click *Next*, select the application you would like to install, then click *Next* to continue

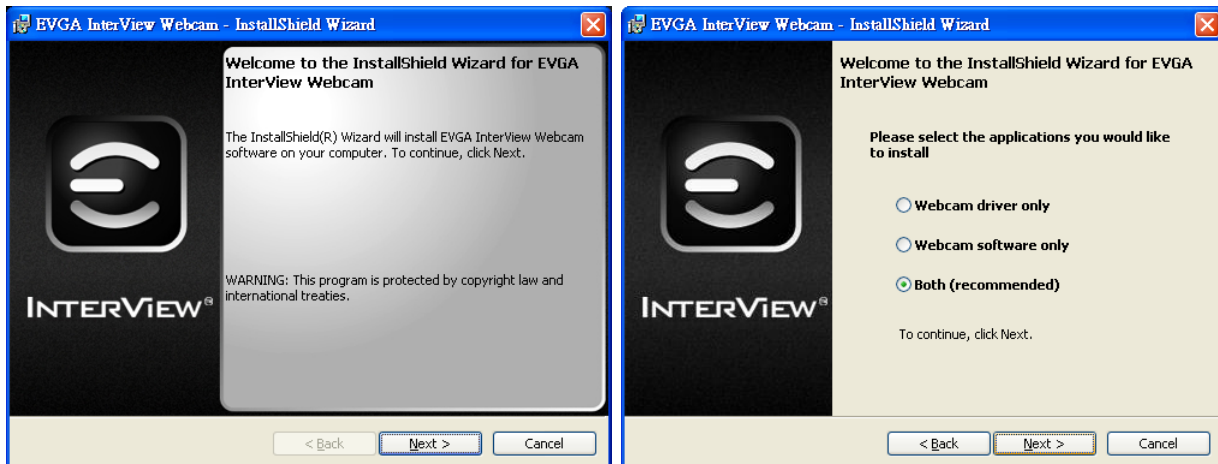

Note: For users who select to install both webcam driver and application, the installation will start from the webcam software then to the webcam driver.

Installing the Webcam Application

- Select the destination folder then click *Install* to begin the installation

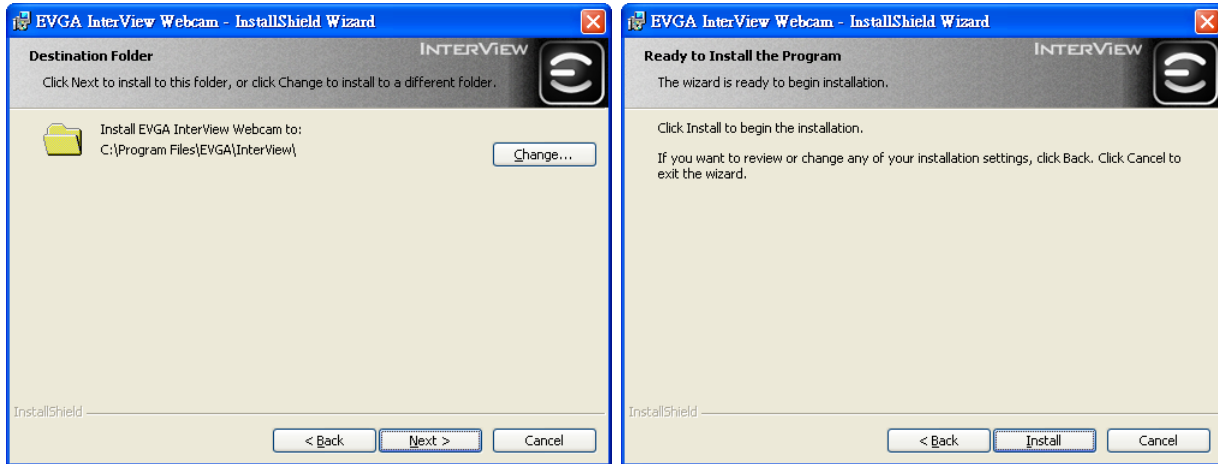

- Installation in process, the dialogue box will automatically close when the installation completes.

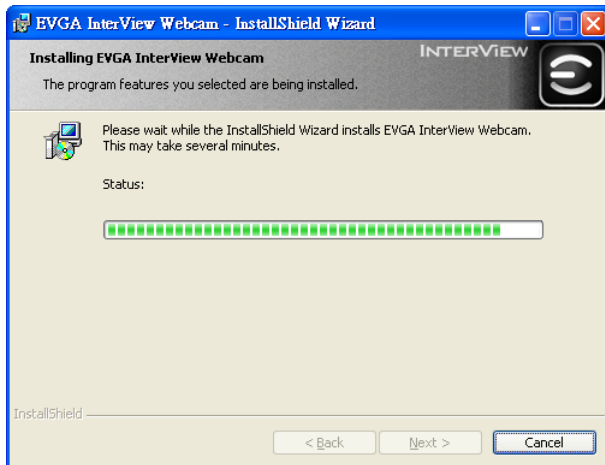

Installing the Webcam Driver

- Click Install

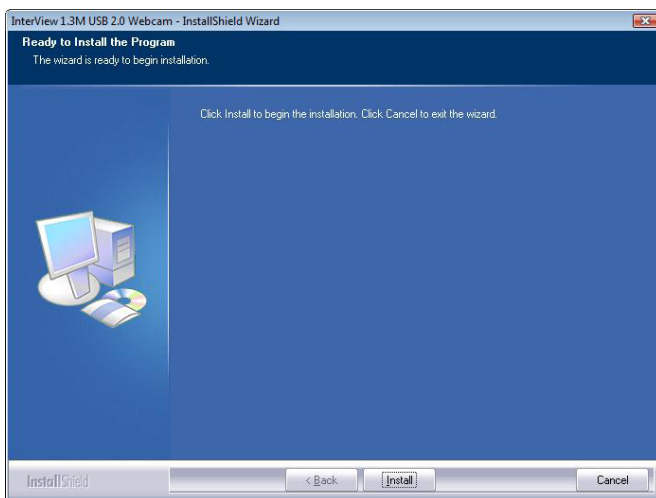

- Click Install

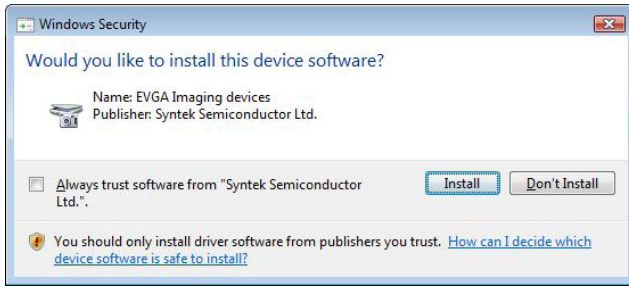

- Click *Finish* then select the option to restart you computer after the installation completes

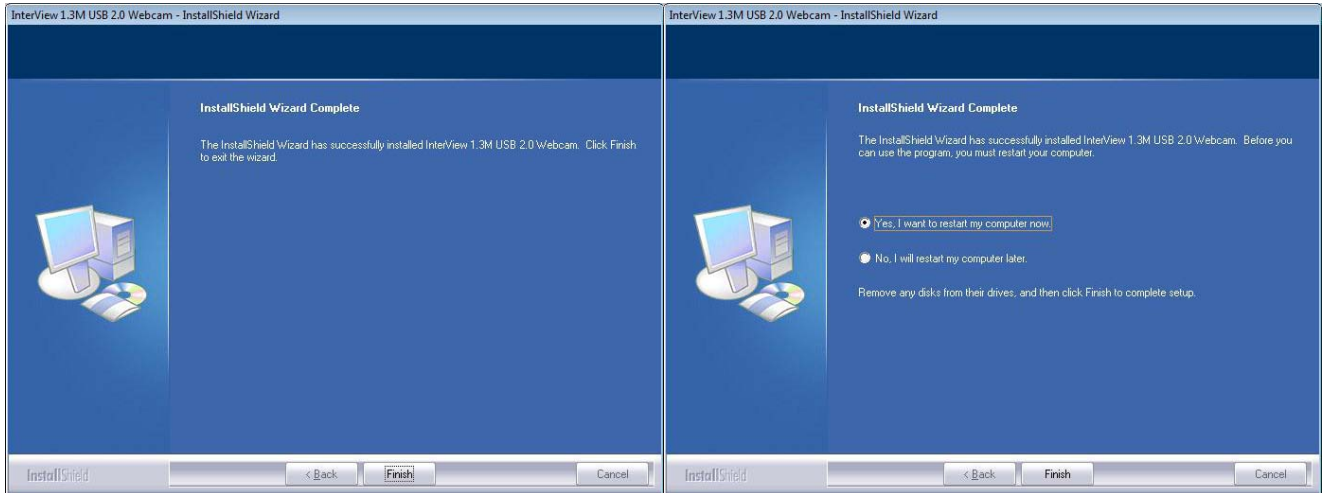

Note: Depending on each user's PC system and hardware performance, it may take 10 to 15 seconds before entering to the next step, please be patient.

- Click *Finish* to exit the wizard, then the computer will automatically restart.



(Step 3) Self Check

To ensure the driver has successfully installed, visit the Device Manager to check if the device name has changed to *InterView USB 2.0 Webcam*. You can find the InterView Control Center under Programs when after the InterView camera application is successfully installed

5.3 Using the InterView Camera Application

Main Panel Layout



1. Display screen
2. Record
3. Snapshot
4. Color setting page
5. Snapshot setting page
6. Record setting page
7. Misc setting page

Color Setting Page

This panel allows users to adjust the color settings by dragging the track bars.



1. Brightness adjustment
2. Contrast adjustment
3. Hue adjustment
4. Saturation adjustment
5. Sharpness adjustment
6. White balance adjustment
7. Gamma adjustment
8. Color / Gray scale
9. Backlight compensation

Snapshot Setting Page

The Interview webcam application allows users to capture a single photo as well as continuous shooting. In this panel, the application allows users to set snapshot functions, such as time intervals and output formats.



1. Photo quantity for continuous shooting (1-30)
2. Time intervals for continuous shooting (500ms – 2000ms)
3. Image format. Options are: BMP / JPEG / GIF
4. Destination file for images
5. Shutter

Record Setting Page

This panel allows adjustments to the recording function of the webcam.



1. Select the audio device to be captured
2. Select the audio recording source. Ex: Microphone
3. Select the audio encoder to encode the audio stream
4. Select the video encoder to encode the video stream
5. Set file limits
6. Set time limits
7. Recording file save path

Misc Setting Page

Within this panel, users can adjust settings that control different aspects of the image.



1. Video Flip: Flips the video horizontally/vertically
2. Exposure control
 - Low Light: avoid under-exposure in low light environment
 - High Light: avoid under-exposure in high light environment.
3. Flicker Reduction: Avoids flicker
4. Picture Quality: Select for better quality or faster speed.

6. TROUBLESHOOTING

6.1 Self-Test Feature Check

Self-Test Feature Check (STFC) allows users to check if the monitor works properly.

1. Turn off both your computer and the monitor
2. Unplug the DMS cable from the back of the computer
3. Turn on the monitor
4. If the monitor is functioning properly, you will see a box in the illustration below

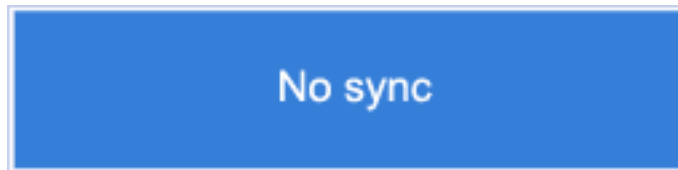

 This box appears during normal operation if the video cable becomes disconnected or damaged.

5. Turn off your monitor and reconnect the video cable; then turn on both your computer and the monitor.
6. If the power indicator remains orange after using the previous procedure, check your VGA card, cable, and computer system; your monitor is functioning properly.

6.2 FAQs

 Before calling for assistance, check the information in this section to see if you can remedy any problems yourself.

Symptoms	Possible Solutions
No picture	<ul style="list-style-type: none"> • Check connection integrity at both ends of the video cable • Electric outlet verification • Ensure power button is depressed fully
No picture or no brightness	<ul style="list-style-type: none"> • Increase brightness via OSD • Perform monitor self-test feature check • Check for bent or broken pins
Picture is fuzzy, blurry or ghosting	<ul style="list-style-type: none"> • Auto Adjust via OSD • Eliminate video extension cables • Perform monitor reset • Lower video resolution or increase font size

Wavy picture or fine movement	<ul style="list-style-type: none"> • Auto Adjust via OSD • Perform monitor reset • Check environmental factors • Relocate and test in another room
LCD screen has spots	<ul style="list-style-type: none"> • Cycle power on-off • These are pixels that are permanently off and is a natural defect that occurs in LCD technology
LCD screen has bright spots	<ul style="list-style-type: none"> • Cycle power on-off • These are pixels that are permanently on and is a natural defect that occurs in LCD technology
Picture too dim or too bright	<ul style="list-style-type: none"> • Perform monitor reset on "Factory Reset" • Auto Adjust via OSD • Adjust brightness via OSD
Screen not centered correctly	<ul style="list-style-type: none"> • Perform monitor reset on "Display Reset" • Auto Adjust via OSD • Adjust brightness via OSD • Ensure monitor is in proper video mode
Screen has one or more lines	<ul style="list-style-type: none"> • Perform monitor reset on "Display Reset" • Auto Adjust via OSD • Perform monitor self-test feature check and determine if these lines are also in self-test mode • Check for bent or broken pins
Screen is scrambled or appears torn	<ul style="list-style-type: none"> • Perform monitor reset on "Display Reset" • Auto Adjust via OSD • Perform monitor self-test feature check to determine if scrambled screen appears in self-test mode • Check for bent or broken pins • Boot up in the "safe mode"
Visible signs of smoke or sparks	<ul style="list-style-type: none"> • Do not perform any troubleshooting steps • Monitor needs to be replaced
Monitor malfunctions on & off	<ul style="list-style-type: none"> • Ensure monitor is in proper video mode • Ensure video cable connection to computer and to the flat panel is secure • Perform monitor reset on "Factory Reset" • Perform monitor self-test feature check to determine if the intermittent problem occurs in self-test mode

- Picture missing color
- Perform monitor self-test feature check
 - Check connection integrity at both end of the video cable
 - Check for bent or broken pins
- Picture color not good
- Change the color to "PC Custom Color" or "MAC Custom Color"
 - Adjust R/G/B value of "PC Custom Color" or "MAC Custom Color"
 - Change the Color Format to "PC RGB" or "YPbPr" (for Video/DVI-HD inputs)
- Faint shadow from the static image displayed appears on the screen
- Use the Power Management feature to turn off the monitor at all times when not in use
 - Alternatively, use a dynamically changing screen saver

7. SERVICE INFORMATION

7.1 Product Registration and Customer Support

Should you require any assistance with the installation or troubleshooting of the EVGA InterView, please visit the Support section of our website at www.evga.com/support. There you'll be able to download drivers, check out our extensive Knowledge Base, and submit technical and customer support inquiries. Be sure to visit the EVGA community message boards: <http://forums.evga.com>

Contact our Customer Service through email to get all of your questions answered and problems resolved – it's fast, it's easy, and it works! If you require immediate assistance, please contact our Customer Service at **888.880.EVGA (3842)**.

Point your browser to www.evga.com/register and have the following information ready before contacting customer service:

- Product Name & Part Number
- UPC Number
- Serial Number

The EVGA Advanced RMA (EAR) Program is a program to protect yourself and your product in the case of product failure. For more details please visit: www.evga.com/EAR

7.2 Pixel Policy

The EVGA monitor is evaluated on the number of acceptable non-performing pixels and the distance between each non-performing pixels. The terms "non-performing" and "defective pixels/sub-pixels" are used interchangeably for ease of identification. All monitors have been tested to ensure they comply with this standard.

To identify non-performing pixels, the monitor shall be viewed under normal operating conditions, preferably in its native resolution, and from a normal viewing distance of at least 50 cm (16 in.).

During the LCD Monitor manufacturing process, it is not uncommon for one or more pixels to become fixed in an unchanging state. The visible result is a fixed pixel that appears as an extremely tiny dark or bright discolored dot. When the pixel remains permanently lit, it is known as a "bright dot." When the pixel remains black, it is known as a "dark dot."

In almost every case, these fixed pixels are hard to see and do not detract from display quality or usability. A display with 1 to 5 bright or dark dots is considered normal and within industry standards.

Your LCD display is subject to replacement if it meets the criteria outlined in the following table:

Product	Bright Dots	Dark Dots	Total Dots
InterView	6 or more	6 or more	Combination of Bright and Dark = 6 or more

7.3 Warranty Terms and Conditions

EVGA monitors are covered by a 3 Year limited warranty with registration within 30 days of the purchase date as stated on the terms and conditions. Please also note the model number, the serial number, the date of purchase, and keep a copy of the purchase invoice on hand.

1. EVGA warrants that the monitor you have purchased is free from manufacturing defects in materials and workmanship when dispatched from our warehouse. The receipt of purchase shall be provided as proof of the date of purchase and the warranty period commences as of that date.
2. The warranty service only covers the monitors which have been purchased in local country.
3. Proof of purchase will be required in the event of any discrepancy.
4. The warranty will not apply to any monitor purchased from a dealer/reseller other than an authorized EVGA dealer/reseller. The warranty automatically becomes void if the product has been physically damaged or rendered defective –
 - (a) as a result of an accident, misuse, fire, lightning, malicious damage, water damage, abuse or other circumstances beyond EVGA's control;
 - (b) by the use of parts or peripherals not authorized by EVGA;
 - (c) as a result of normal wear and tear;
 - (d) by use in an improper operating environment;
 - (e) by modification of the monitor;
 - (f) by the serial number or product code sticker being removed or defaced;
 - (g) as a result of a service rendered by anyone other than EVGA authorized service centre or its authorized service agents
 - (h) as a result of the monitor not being operated in conformity with EVGA's user manual.
5. In all circumstances, the user must ensure that the monitor is packed in appropriate packing. Any damage due to improper packing will be chargeable to the customer.
6. EVGA authorized service centre will be chargeable at current applicable hourly rates to the customer if –
 - (a) the technician finds the problem is user related;
 - (b) caused by change in normal settings of the monitor or caused by user computer (software, settings ... etc);
 - (c) determined to be causes not covered by this warranty and/or fallen within the scope as prescribed in item 5.
7. The customer must ensure that they are available when the service centers' representative arrives to pick up or deliver the monitor. Any additional visits made due to the customer's unavailability will be chargeable to the customer or the customer can bring (or pick up) the monitor to (from) the service centers' agent at their own cost.

8. Software related faults resulting from incorrect software installation or usage or software viruses or software inherent bugs shall not be considered as product faults and may incur a charge for rectification.

8. COMPLIANCE INFORMATION

8.1 FCC Notice

This device complies with FCC Rules Part 15, Operation is subject to the following two conditions:

- 1) This device may not cause harmful interference, and this device must accept any interference received, including interference that may cause undesired operation.
- 2) This equipment has been tested and found to comply with the limits for a Class B digital device, pursuant to Part 15 of the FCC Rules.

These limits are designed to provide reasonable protection against harmful interference in a residential installation. This equipment generates, uses and can radiate radio frequency energy and, if not installed and used in accordance with the manufacturer's instructions, may cause harmful interference to radio communications. However, there is no guarantee that interference will not occur in a particular installation.

If this equipment does cause harmful interference to radio or television reception, which can be determined by turning the equipment off and on, the user is encouraged to try to correct the interference by one or more of the following measures:

- 1) Increase the separation between the equipment and signal source.
- 2) Connect the equipment to an outlet on a circuit different from that to which the signal source is connected.
- 3) Consult the dealer or an experienced computer technician for help.
- 4) The use of shielded cables for connection of the monitor to the graphics card is required to ensure compliance with FCC regulations. Changes or modifications to this unit not expressly approved by the party responsible for compliance could void the user's authority to operate this equipment.

The following information is provided on the device or devices covered in this document in compliance with the FCC regulations:

Product name: Dual Monitor System

Model number: EVGA InterView™ 1700

Company name: EVGA® Corporation

2900 Saturn Street, Suite B
Brea, California, 92821 USA

9. LEGAL INFORMATION

9.1 Trademark Information

- 1) EVGA Corp., EVGA, the EVGA logo and combinations,
- 2) INTERVIEW and INTERVIEW in lower or cap combinations,

thereof are trademarks of EVGA Corp. All brand names, company names, service marks, logos, and trademarks of the company, or its affiliates or licensors are trademarks or registered trademarks of the company or its subsidiaries, affiliates or licensors in the US and other countries. Other company, products and service names may be trademarks or service marks of others. EVGA reserves the right to terminate this license if there is a violation of its terms or default by the Original Purchaser. Upon termination, for any reason, all copies of Software and materials must be immediately returned to EVGA and the Original Purchaser shall be liable to EVGA CORP for any and all damages suffered as a result of the violation or default.

9.2 Software License Agreement

This EVGA software (the "software") is copyrighted by EVGA CORP and is protected by US law. All rights reserved. The purchaser is granted a license to use the software only, subject to the following restrictions and limitations:

- 1) The license is for the original purchaser only, it is transferable so long as all items bundled with the software are transferred to the same individual as a sale (e.g. all software, manuals, hardware, etc.)
- 2) The original purchaser may use the software on a single computer owned or leased by the original purchaser. You may not use the software on more than a single machine, even if you own or lease more than one machine, without the written consent of EVGA
- 3) The original purchaser may make backup copies of the software for his or her own use only, subject to the use limitations of this license. The original purchaser may not engage in, nor permit third parties to engage in, any of the following:
 - Providing or disclosing the software to third parties
 - Providing use of the software in a computer service business, network, time-sharing network
 - Making alterations or copies of any kind in the software (except as permitted above)
 - Attempting to un-assemble, de-compile or reverse engineer the software in any way
 - Granting sublicenses, leases, or rights in the software to others
 - Making copies, or verbal or media translations, of the user's guide
 - Making telecommunication data transmissions of the software

9.3 Rights

ALL MATERIAL INCLUDING BUT NOT LIMITED TO, TEXT, DATA, DESIGN SPECIFICATIONS, DIAGNOSTICS, GRAPHICS, LOGOS, REFERENCE BOARDS, FILES, IMAGES, DRAWINGS, AND SOFTWARE INCLUDING THIS DOCUMENT AND THE SOFTWARE ITSELF (TOGETHER AND SEPARATELY) IS OWNED, CONTROLLED BY, LICENSED TO, OR USED WITH PERMISSION BY COMPANY AND IS PROTECTED BY COPYRIGHT, TRADEMARK, AND OTHER INTELLECTUAL PROPERTY RIGHTS. ALL IS BEING PROVIDED "AS IS", EVGA CORPORATION MAKES NO WARRANTIES, WHETHER EXPRESS OR IMPLIED, STATUTORY OR OTHERWISE WITH RESPECT TO THE MATERIALS AND EXPRESSLY DISCLAIMS ALL IMPLIED WARRANTIES OF NON-INFRINGEMENT, MERCHANTABILITY, AND FITNESS FOR A PARTICULAR PURPOSE. IN NO EVENT SHALL THE LIABILITY OF EVGA CORPORATION FOR CLAIMS ARISING FROM THE USE OF THE MATERIALS BY ANYONE EXCEED THE ORIGINAL PURCHASE PRICE OF THE MATERIALS (OR REPLACEMENT OF THE MATERIALS AT EVGA CORPORATION'S OPTION). ALL INFORMATION FURNISHED IS BELIEVED TO BE ACCURATE AND RELIABLE. HOWEVER, EVGA CORPORATION ASSUMES NO RESPONSIBILITY FOR THE CONSEQUENCES OF USE OF SUCH INFORMATION OR FOR ANY INFRINGEMENT OF PATENTS OR OTHER RIGHTS OF THIRD PARTIES THAT MAY RESULT FROM ITS USE, OR USE OF THE SOFTWARE. NO LICENSE IS GRANTED BY IMPLICATION OR OTHERWISE UNDER ANY PATENT OR PATENT RIGHTS OF EVGA CORPORATION EXCEPT AS EXPRESSLY PROVIDED HEREIN. ALL SPECIFICATIONS MENTIONED IN THIS PUBLICATION ARE SUBJECT TO CHANGE WITHOUT NOTICE.

