

User Guide

EVGA X99 FTW-K

Specs and Initial Installation

Table of Contents

Before you Begin.....	- 1 -
Parts Not in the kit	- 1 -
Intentions of the kit.....	- 1 -
Motherboard Specifications	- 4 -
Unpacking and Parts Descriptions.....	- 5 -
LED Legend.....	- 5 -
Component Legend.....	- 6 -
Rear I/O Panel Legend.....	- 6 -
Rear I/O Panel Legend.....	- 6 -
PCI-E Slot Breakdown	- 8 -
M.2 Slot Breakdown.....	Error! Bookmark not defined.
M.2, PCI-E, and NVMe SSD Installation information	- 9 -
Installing the CPU.....	- 13 -
Installing the Cooling Device.....	- 13 -
Installing System Memory (DIMMs).....	- 17 -
Installing the I/O Shield.....	- 17 -
Installing the Motherboard.....	- 18 -
Securing the Motherboard into a System Case	- 20 -
Connecting Cables	- 20 -
24pin ATX Power (ATX_PWR_24P).....	- 21 -

8-pin ATX 12V Power (PWR 8P1)..... - 22 -

Front Panel Header - 22 -

Fan Headers - 23 -

USB Headers - 23 -

Front Panel Audio Header - 25 -

S/PDIF Header..... - 27 -

Thunderbolt Header..... **Error! Bookmark not defined.**

Probe It Header..... - 34 -

6pin PCI-E..... - 40 -

SATA Ports..... - 41 -

Onboard Buttons - 41 -

Clear CMOS Button - 42 -

RESET and POWER Button - 43 -

Installing Drivers and Software..... - 44 -

Windows 10 / 8 / 7 Driver Installation..... - 49 -

Online and Community resources..... - 49 -

Post Port Debug LED - 49 -

POST Codes - 49 -

Glossary of Terms - 49 -

Compliance Information - 52 -

Before You Begin...

EVGA welcomes you to the next generation of ground-breaking performance: the X99 FTW-K! The X99 platform redefines high-performance with the introduction of the first ever quad-channel DDR4 architecture fueled by Intel's Haswell-E/Broadwell-E CPU family for up to 128GBs of RAM running at a maximum memory speed of up to 3200MHz+ (OC), all made possible due to the 4-layer memory T-Routing design. The X99 FTW-K is built with an 8-layer Hybrid Black PCB, featuring a CPU socket with 150% higher Gold content powered by an Advanced 8-phase Digital VRM (IR3563B+IR3350), providing industry-leading stability for all your applications.

Furthermore, this board is designed not ONLY for peak overclocking, but also fully-featured to support any/all peripherals and functions available, 4-Way SLI support without the need for PLX chips, 2 Gigabit LAN, Intel AIC with Thunderbolt support, right-angle power connectors, PCI-E disable switches and much more!

Lastly, a motherboard is only as good as its BIOS, and the EVGA X99 FTW-K features a revamped GUI BIOS with a focus on overclocking and functionality in a lean, straight-forward package. You should expect nothing less from a modern-enthusiast BIOS.

With all these features above, and many more, EVGA is redefining motherboard performance!

Parts NOT in the Kit

This kit contains all the hardware necessary to install and connect your new EVGA X99 FTW-K Motherboard. However, it does NOT contain the following items that must be purchased separately in order to make the system fully functional and install an Operating System:

- ❑ **Intel Socket 2011-3 Processor**
- ❑ **DDR4 System Memory**
- ❑ **CPU Cooling Device**
- ❑ **PCI Express Graphics Card**
- ❑ **Power Supply**
- ❑ **Hard Drive or SSD**
- ❑ **Keyboard / Mouse**
- ❑ **Monitor**
- ❑ **(Optional) Optical Drive**

EVGA assumes you have purchased all the necessary parts needed to allow for proper system functionality. For a full list of supported CPUs on this motherboard, please visit www.evga.com/support/motherboard

Intentions of the Kit

This kit provides you with the motherboard and all connecting cables necessary to install the motherboard into a PC case.

When replacing a motherboard in a PC case, you will need to reinstall an operating system even though the current storage drive may already have one installed.

Motherboard

Motherboard Specifications

- ❑ **Size:**
EATX form factor of 12 inches x 10.375 inches (305x264mm)
- ❑ **Microprocessor support:**
Intel Socket 2011-3 Processor
- ❑ **Operating Systems:**
Supports Windows 10 / 8 / 7
- ❑ **Contains Intel X99 chipset**
- ❑ **System Memory support:**
Supports Quad channel DDR4 up to 3200MHz+ (OC).
Supports up to 128GB of DDR4 memory.
- ❑ **USB 2.0 Ports:**
8x from Intel X99 PCH – 4x external, 4x internal via 2 FP headers
Supports hot plug
Supports wake-up from S3 mode
Supports USB 2.0 protocol up to a 480 Mbps transmission rate
- ❑ **USB 3.0 Ports:**
6x from Intel X99 PCH – 4x external, 4x internal via 1 FP headers
2x from AsMedia (ASM1042A) controller, on single internal FP Header.
Supports transfer speeds up to 5Gbps
Backwards compatible USB 2.0 and USB 1.1 support
- ❑ **USB 3.1 Ports:**
2x from AsMedia (ASM1142) Controller – 2x external, 1x Type C, 1x Type A
Supports transfer speeds up to 10Gbps
Backwards compatible USB 3.0, USB 2.0 and USB 1.1 support*

- ❑ **SATA Ports:**
 - Intel X99 PCH Controller
 - 6x SATA 3/6G (600 MB/s) data transfer rate
 - Support for RAID 0, RAID 1, RAID 5, AND RAID 10
 - Supports hot plug
 - 4x SATA3/6G AHCI Only
- ❑ **Onboard LAN:**
 - 1x Intel i218v Gigabit Ethernet
 - 1x Killer E2400 Gigabit Ethernet MAC+PHY
 - Supports 10/100/1000 Mb/sec Ethernet
 - Ethernet Teaming NOT Supported
 - Killer Doubleshot supported with Killer Wireless AC 1535 or 1525**
- ❑ **Onboard Audio:**
 - Realtek Audio (ALC1150)
 - Supports 8-channel (7.1) audio
 - Supports Optical Output
- ❑ **PCI-E 3.0 Support:**
 - Low power consumption and power management features
- ❑ **Power Functions:**
 - Supports ACPI (Advanced Configuration and Power Interface)
 - Supports S0 (normal), S3 (suspend to RAM), S4 (Suspend to disk - depends on OS), and S5 (soft - off)
- ❑ **Expansion Slots:**
 - 5x PCI-E 16x slot 2x16/8, 3x8
 - 1x PCI-E 1x slot

* USB 3.1 Type C will support previous standards but only with an adapter.

** Killer Wireless AC is not included and needs to be purchased separately.

Unpacking and Parts Descriptions

The following accessories are included with the EVGA X99 FTW-K Motherboard:



The EVGA X99 FTW-K Motherboard

This motherboard contains the Intel X99 chipset.



I/O Shield

Installs in the system case to block radio frequency transmissions, protect internal components from dust, foreign objects, and aids in proper airflow within the chassis.



2x SATA 3G/6G Data Cables

Used to support the SATA protocol and each one connects a single drive to the motherboard.



USB 2.0 header bracket

Connects USB 2.0 headers to the rear of the case, at the card slots.



I/O Cover

This optional cover attaches to the PCB and covers the I/O area



2Way SLI Bridge

Link for attaching 2 cards in SLI.



ProbeIt Connector

Provides a connector to measure various power levels live, under load.



Case Badge

EVGA enthusiast Case Badge



Installation CD

Contains drivers and software needed to setup the motherboard.



User Manual

The user manual you are reading right now!

Intel X99 FTW-K Motherboard LED reference

The EVGA X99 FTW-K Motherboard has several LEDs indicating power, connectivity, and activity. Below is the location of the LEDs and their function.

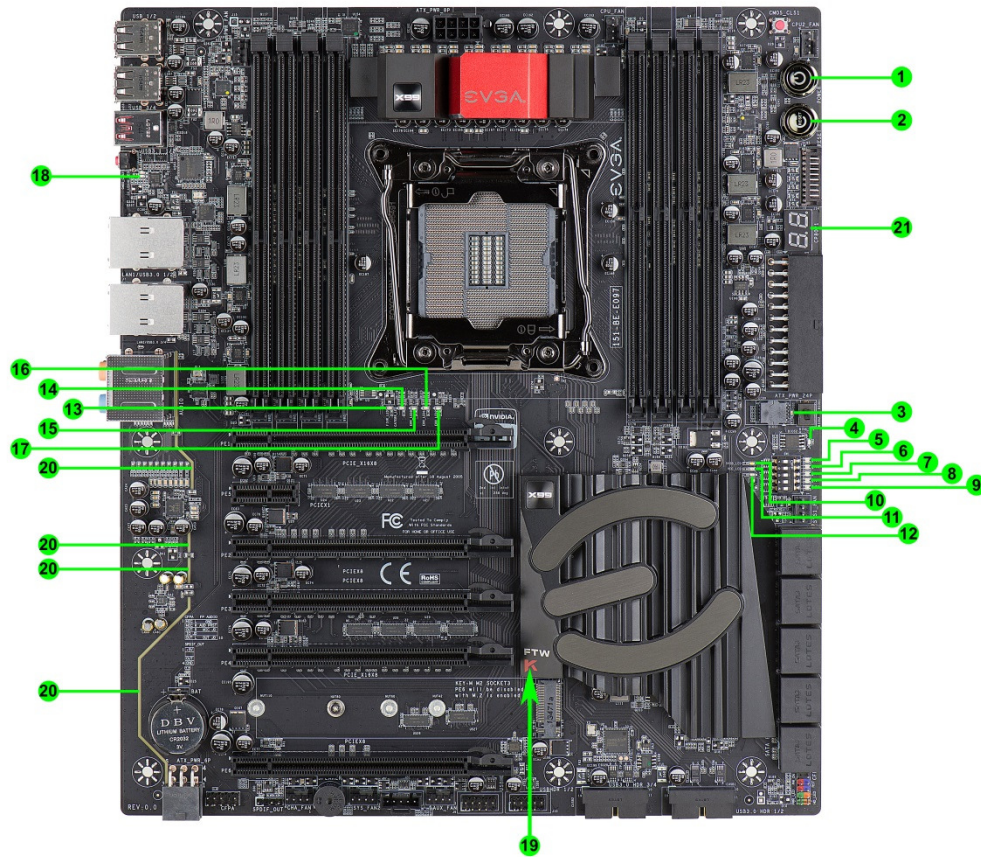

LED Legend		
1. Power Button	8. PE5 Status/Mode	15. ERR_LED0
2. Reset Button	9. PE6 Status/Mode	16. ERR_LED1
3. Removable BIOS LED	10. 5VSB	17. ERR_LED2
4. Fixed BIOS LED	11. VCC	18. CC_LED
5. PE1 Status/Mode	12. VSM	19. M.2 Activity
6. PE3 Status/Mode	13. FIVR	20. Backlit/Shielded Audio Trace
7. PE4 Status/Mode	14. CATERR	21. POSTCODE Indicator (see page 44 for hex-code list)

1. Power Button
 - a. RED: Power On
 - b. GREEN: Standby
2. Reset Button
 - a. WHITE: HDD/SSD Active
3. Removable BIOS LED
 - a. RED: Active BIOS Chip (only 1 will be lit at a time)
 - b. This BIOS chip can be removed and replaced while the motherboard is powered off. Please contact EVGA Support for any concerns with the BIOS chip, and never remove the chip while the PC is powered on.
4. Fixed BIOS LED
 - a. RED: Active BIOS Chip (only 1 will be lit at a time)
5. PCI-Express LED for PE1. The LED will remain off when this PCI-e slot is disabled or unpopulated.
 - a. GREEN: Operating at PCI-Express Gen1 speed
 - b. YELLOW: Operating at PCI-Express Gen2 speed
 - c. RED: Operating at PCI-Express Gen3 speed
6. PCI-Express LED for PE3. The LED will remain off when this PCI-e slot is disabled or unpopulated.
 - a. GREEN: Operating at PCI-Express Gen1 speed
 - b. YELLOW: Operating at PCI-Express Gen2 speed
 - c. RED: Operating at PCI-Express Gen3 speed
7. PCI-Express LED for PE4. The LED will remain off when this PCI-e slot is disabled or unpopulated.
 - a. GREEN: Operating at PCI-Express Gen1 speed
 - b. YELLOW: Operating at PCI-Express Gen2 speed
 - c. RED: Operating at PCI-Express Gen3 speed

8. PCI-Express LED for PE5. The LED will remain off when this PCI-e slot is disabled or unpopulated.
 - a. GREEN: Operating at PCI-Express Gen1 speed
 - b. YELLOW: Operating at PCI-Express Gen2 speed
 - c. RED: Operating at PCI-Express Gen3 speed
9. PCI-Express LED for PE6. The LED will remain off when this PCI-e slot is disabled or unpopulated.
 - a. GREEN: Operating at PCI-Express Gen1 speed
 - b. YELLOW: Operating at PCI-Express Gen2 speed
 - c. RED: Operating at PCI-Express Gen3 speed
10. 5VSB
 - a. WHITE: Voltage detected (Does not mean PSU is outputting in-spec, only that this specific voltage is detected)
11. VCC
 - a. RED: Voltage detected (Does not mean PSU is outputting in-spec, only that this specific voltage is detected)
12. VSM
 - a. YELLOW: Voltage detected (Does not mean PSU is outputting in-spec, only that this specific voltage is detected)
13. FIVR
 - a. RED: Indicates CPU integrated voltage regulation failure.
 - b. Off: No issues detected on FIVR
14. CATERR
 - a. CATERR stands for Catastrophic Error on the processor.
 - b. RED: Processor error has occurred.
 - c. Off: No error state detected in the CPU.
15. ERR-LED0
 - a. Error detected for CPU internal I/O.
 - b. RED: Hardware correctable error detected.
 - c. OFF: No error state detected.
16. ERR-LED1
 - a. Error detected for CPU internal I/O.
 - b. RED: Non-fatal error detected.
 - c. OFF: No error state detected.
17. ERR-LED2
 - a. Error detected for CPU internal I/O.
 - b. RED: Fatal error detected.
 - c. OFF: No error state detected.

18. CC_LED

- a. USB 3.1 Type-C detection.
- b. RED: Indicates device is attached and detected to USB Type C.
- c. OFF: No device detected.

19. M.2

- a. RED: M.2 detection/activity.
 - i. Some devices do not have full activity detection support; for example, the LED will turn on when an SM951 drive is attached and blink while accessing. However, a XP941 drive does not support that function.
- b. OFF: No device attached.

20. Audio Trace

- a. RED: This LED backlights the isolated Audio traces. When the LED is on, it merely shows the PC is on and the light is not disabled in BIOS. The lights may be enabled/disabled in BIOS under the option “Audio Backlight”.

21. Postcode indicator

- a. After bootup, this will display the CPU temp.
- b. During boot it will cycle many different hexadecimal post codes with a range of 00-FF and this indicates what aspect of the Power On Self Test (POST) is currently running.
 - i. For list of Post Codes, please see page 44.

Intel X99 FTW-K Motherboard Component Legend

The EVGA X99 FTW-K Motherboard with the Intel X99 and PCH Chipset. Figure 1 shows the motherboard and Figure 2 shows the back panel connectors

FIGURE 1. X99 FTW-K Motherboard Layout

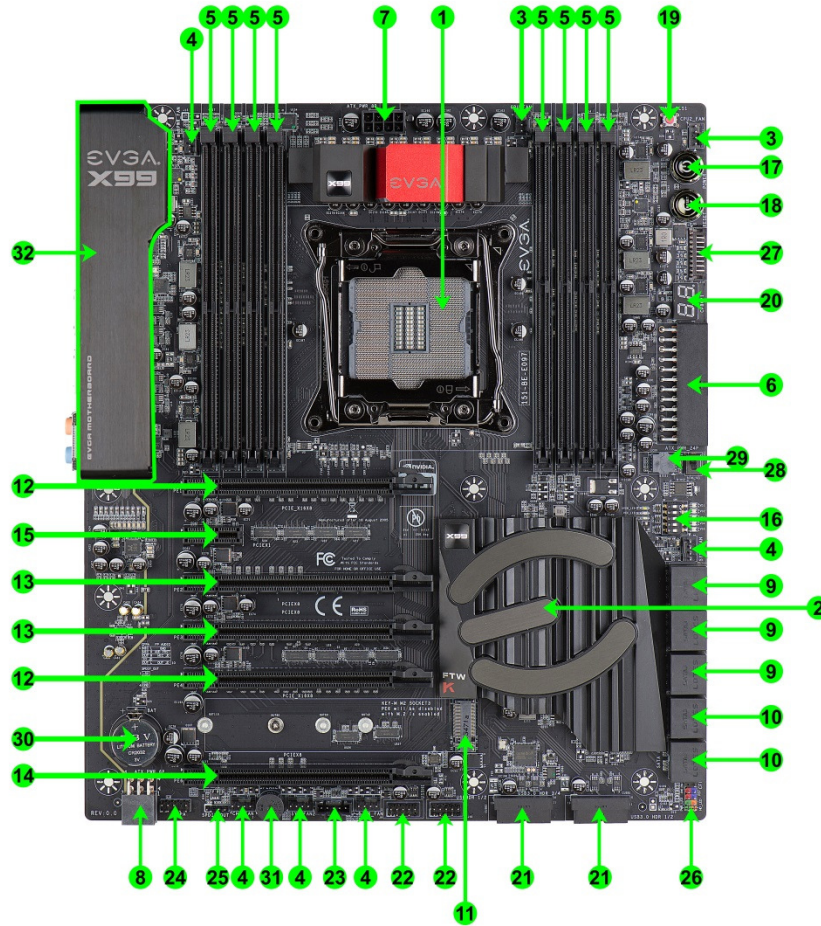

Component Legend		
1. CPU Socket 2011-3	12. PCI-E Slot 16x/8x	23. Thunderbolt GPIO Connector
2. Intel X99 Southbridge	13. PCI-E Slot 8x	24. Front Panel Audio Connector
3. CPU Fan Header (1 amp PWM)	14. PCI-E Slot 8x/4x (28 lane CPU)	25. S/PDIF Out
4. Fan Headers (1 amp DC/PWM)	15. PCI-E Slot 1x	26. Front Panel Connectors
5. DDR4 Memory DIMM Slots 1-8	16. PCI-E Disable Dipswitches	27. Probe It Header
6. 24-pin ATX power connector	17. Power Button	28. BIOS Selector Switch
7. 8 pin EPS Connector	18. Reset Button	29. Removable BIOS Chip
8. Supplemental PCI-E 6pin Power	19. CMOS Reset Button	30. CMOS Battery
9. Intel Sata 6G RAID Ports	20. Debug LED / CPU Temp Monitor	31. PC Speaker
10. Intel Sata 6G AHCI Ports	21. USB 3.0 Headers	32. Rear Panel Connectors (Figure 2)
11. M.2 Socket 3 Key-M 110mm	22. USB 2.0 Headers	

Figure 2. Chassis Rear Panel Connectors

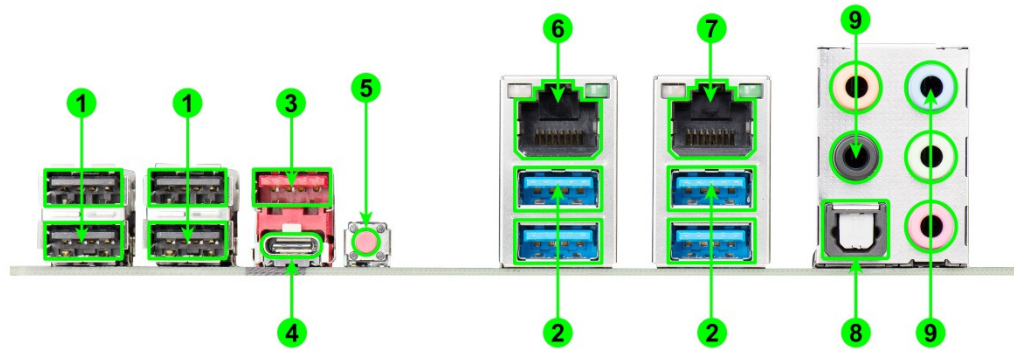

I/O Hub		
1. USB 2.0	4. USB 3.1 type C	7. Killer E2400 NIC
2. USB 3.0	5. BIOS/CMOS Reset	8. Optical Out
3. USB 3.1 type A	6. Intel I 218 NIC	9. Analog Audio Jacks

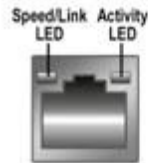

Speed/Link LED Status	Description
Orange	1000 Mbps data rate
Green	100 Mbps data rate
Off	10 Mbps data rate

Activity LED Status	Description
Off	No data transmission
Blinking (Green)	Data transmission

Analog Audio Port Breakdown	2/2.1 (Channel)	4.0/4.1 (Channel)	5.1 (6 Channel)
	Blue	Line In	Line In
Green	Line Out/ Speaker Out	Front Speaker/ Speaker+Sub out	Front Speaker/ Speaker+Sub out
Pink	Mic In	Mic In	Mic In
Black		Rear Speaker Out	Rear Speaker Out
Orange			Center/Voice Channel

* Only used in 7.1 and is changed via Realtek Software from within Windows.

Card Slots

The X99 FTW-K features 5 x16 PCI-E slots, 1 x1 PCI-E slot, and a Socket 3 KeyM M.2 slot as well accommodating Key M devices of 42mm, 60mm, 80mm, and 110mm.

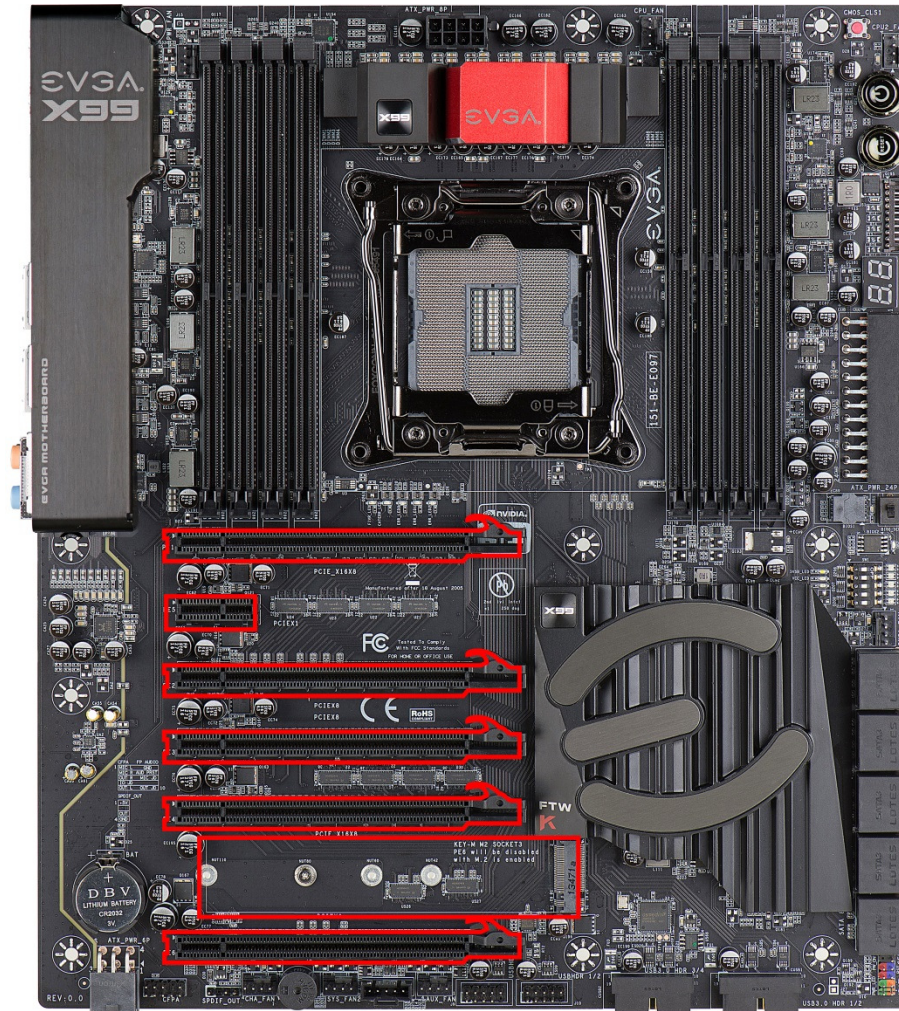

PCI-E Slot Breakdown

PCI-E Lane Distribution (40 Lane Processor)

- ❑ PE1 – x16 (x8 if PE3 is used)
- ❑ PE2 – x1 (Gen2, lane is pulled from PCH)
- ❑ PE3 – x8
- ❑ PE4 – x8
- ❑ PE5 – x16 (x8 if PE4 is used)
- ❑ PE6 – x8 (Disabled if M.2 is used)

PCI-E Lane Distribution (28 Lane Processor)

- ❑ PE1 – x16 (x8 if PE3 are used)
- ❑ PE2 – x1 (Gen2, lane is pulled from PCH)
- ❑ PE3 – x8
- ❑ ~~PE4 – x8~~ (Not functional with a 28 lane processor.)
- ❑ PE5 – x8
- ❑ PE6 – x4 (Disabled if M.2 is used)

M.2 Slot Breakdown

M.2 Lane Distribution (40/28 Lane Processors)

- ❑ M.2 Key M (110mm) – x4 (Gen3, uses 4 lanes from CPU rather than PCH)
 - Using the M.2 DISABLES PE6
 - M.2 Enable/Disable is set within the BIOS

M.2 SSD, PCI-e SSD, and NVMe SSD Installation steps

M.2 is a card bus that through different connector types can connect many types of devices, such as Wi-Fi to SSD's, in a very small and power efficient package that is also very fast. M.2 devices can be connected to a M.2 card slot on the motherboard or through PCI-E on a M.2 to PCI-E adapter. There are also PCI-E native drives of this nature, such as the Intel 750. NVMe stands for Non-Volatile Memory Express, and is a high performance standard for M.2/PCI-E SSD's. Most NVMe drives will require their own device drivers during the Operating System installation to be used as a boot drive, whether in M.2 or PCI-E form.

M.2/PCI-E share resources with other components on the motherboard, which may limit some hardware combinations. **PLEASE SEE CHART ON PREVIOUS PAGE FOR A DETAILED BREAKDOWN OF SHARED RESOURCES.**

M.2 Physical Installation

1. Connect the section of the card with the gold fingers into the M.2 slot. The M.2 device will initially connect at an angle; this is normal.
2. Push the outside of the SSD down down, so that the SSD is parallel with the motherboard.
3. Make sure the SSD is in straight and fully connected. You may use the bolt hole at the end of the SSD to align it with the threaded hole on the motherboard, and screw down the device.
 - a. If the SSD does not align correctly, remove and reseat the M.2 device; the notch at the end of the SSD should always align with the threaded hole on the motherboard.
4. **DO NOT OVER-TIGHTEN** the retention screw, as it may damage the threads on the motherboard and cause irreparable damage to the SSD.

PCI-E Physical Installation

1. Install the SSD into any available PCI-E slot with at least 4x Lanes available (Gen3 Lanes are preferred for better speed, however Gen2 Lanes will still outperform the top end of SATA SSD's).
 - a. Please refer to page 15 under PCI-E Lane Breakdown for lane specifics, as the PCI-E Lane allotment will vary based on the installed CPU.
2. Attach the SSD's mounting bracket to the back of the case.

3. Native PCI-E drives will not normally require a separate power or data cable attached; all power and data transfers are done through the PCI-E slot.

BIOS Setup and Windows Installation for M.2 and PCI-E NVMe SSD's

1. Remember, NVMe is a new standard and older operating systems do not have native support. Many NVMe drives require certain steps to make the drive bootable, even with current operating systems. **PLEASE FULLY READ THE INSTRUCTIONS THAT COME WITH YOUR M.2 or PCI-E NVMe SSD BEFORE INSTALLATION.**
2. After following your SSD's instructions and its respective Physical installation instructions above, power on the PC and enter the BIOS/UEFI by pressing the F2 key repeatedly.
3. Once in BIOS/UEFI, navigate to the "BOOT" section. Then go down to the "CSM Configuration" heading and press enter, or click on it with your mouse.
 - a. For Windows 10 / 8.1: Set "Launch Storage OpROM Policy" to "UEFI". Then set "Launch CSM" to "Disable".
 - b. For Windows 7: Windows 7 does ****NOT**** have native support for NVMe, and limited UEFI support. In Windows 7, "Launch CSM" has to remain enabled, but set "Launch Storage OpROM Policy" to "UEFI".
4. Press F10 to save and exit the BIOS/UEFI.
5. Press Del on reboot to reenter BIOS/UEFI.
 - a. If you are using a SSD-attached via PCI-E, proceed to step **6**.
 - b. If you are using the motherboard's M.2 slot, proceed to step **8**.
6. If you are using an SSD connected via PCI-E (e.g. an Intel 750) or through an adapter that connects a M.2 SSD to PCI-E, go to "Advanced – PCIe Configuration" and verify that the device shows on the slot you have it installed.
 - a. Verify the lane count and PCI-E Generation. It should state "x4 Gen3".
7. Next check the Dashboard on the upper right. The populated slot, lanes used, and PCIE Generation should all match the information found in the previous step.
 - a. Proceed to step **9** when done.
8. If you are using a SSD connected to the motherboard's M.2 slot, re-enter the BIOS/UEFI and go to "Advanced – Onboard Device Configuration", and set "M.2 Socket3" to "Enable".

9. Go to the “Boot” Section, set “Boot Mode Select” to UEFI, and set first boot device to “Hard Disk:Windows Boot Manager”.
10. Press F10 to save and exit. Insert/Connect your Operating System install media and reboot.
11. Begin the Windows installation. During the drive selection step, you may need to load additional drivers that are provided by the SSD’s manufacturer, which would be covered in the SSD manual. If these steps are not followed you will likely be unable to install the Operating System to the SSD and make it bootable.

Preparing the Motherboard

Installing the CPU

Be very careful when handling the CPU. Hold the processor only by the edges and do not touch the bottom of the processor.

Note: Use extreme caution when working with the CPU to not damage any pins in the CPU socket on the motherboard!

Use the following procedure to install the CPU onto the motherboard:

1. Unhook the left socket lever by pushing down and towards the socket.
2. Unhook the right socket lever by pushing down and towards the socket.
3. Gently press the left socket lever and the load plate will lift from the socket.

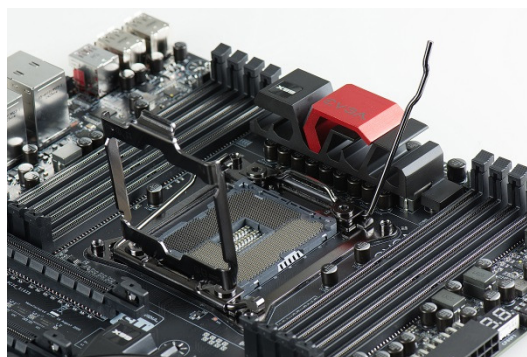
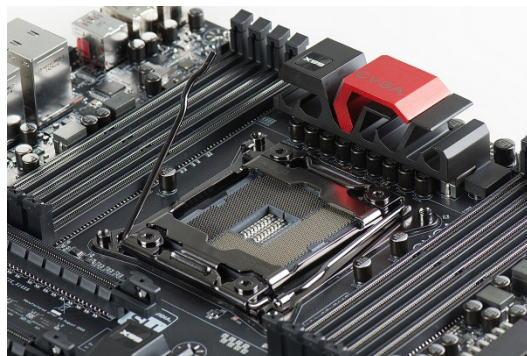

4. Open the load plate and make sure to not damage any of the pins inside of the socket.

Note: After removing the CPU socket cover, it is recommended to store it in case you ever need to transport your motherboard. If you ever remove the CPU, it is highly recommended to reinstall the socket cover.

5. Align the notches on the CPU to the notches in the socket.
6. Lower the processor straight down into the socket.

Note: Make sure the CPU is fully seated and level in the socket.

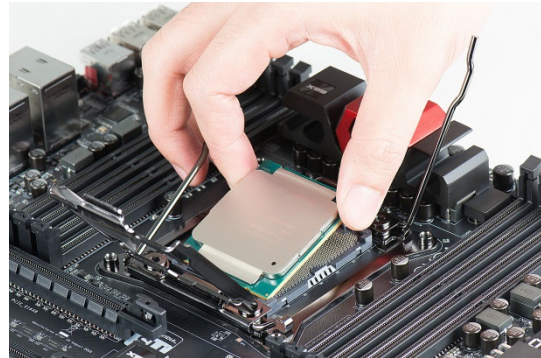

7. Lower the load plate so it is resting on the CPU.
8. Press the right socket lever down to lock into place.
9. Carefully lock the left lever back into place.

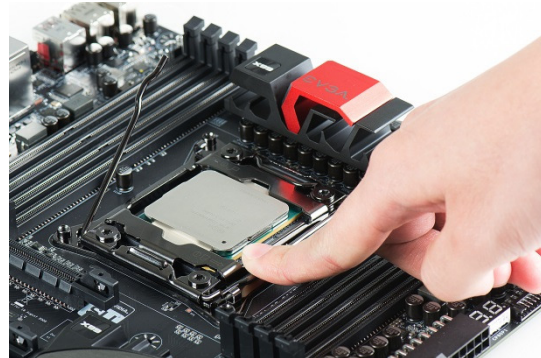

Installing the CPU Cooling Device

There are many different cooling devices that can be used with this motherboard. Follow the instructions that come with your cooling assembly.

Installing System Memory (DIMMs)

Your X99 FTW-K has (8) 288-pin slots for DDR4 memory. These slots support 4GB, 8GB and 16GB DDR4 DIMMs. There must be at least one memory slot populated to ensure normal operation.

The Intel X99 chipset supports quad-channel DDR4 memory, a maximum of 128GB and up to 3200MHz+ (OC) in quad-channel configuration. You must populate odd-slots (1, 3, 5, 7) first. The board will not boot if only even-slots (2, 4, 6, 8) are populated.

Use the following procedure to install memory DIMMs. Note that there is an off-center gap near the center of the DIMM slots. This matches the gap on a DDR4 DIMM to ensure the memory is installed properly, and to prevent the incorrect installation of other types of DDR-memory, such as DDR3.

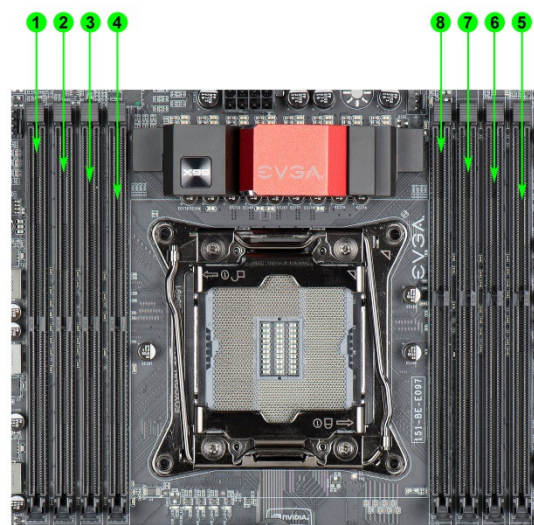

1. Unlock a DIMM slot by pressing the module clips on top side outward.

2. Align the memory module to the DIMM slot, and insert the module vertically into the DIMM slot, pressing straight down to seat the module. The plastic clips at top side of the DIMM slot automatically lock the DIMM into the connector.

Note: The memory controller on most Haswell-E and Broadwell-E CPUs runs at a default frequency of 2133MHz. To achieve memory speeds above 2133MHz+ may require manual setting of the memory timings, frequency and voltages and/or overclocking of the CPU.

Refer to the memory manufacturer specifications for the recommended memory timings. For overclocking support you can visit our forums: <http://forums.evga.com/>

Installing the I/O Shield

The motherboard kit comes with an I/O shield that is used to block internal components from dust and foreign objects, and promotes correct airflow within the chassis.

Before installing the motherboard, install the I/O shield from the inside of the chassis. Press the I/O shield into place and make sure it fits securely.

Also included is an I/O cover. This I/O cover adds a unique appearance to the I/O area of the motherboard and is completely optional. If you wish to use the cover, please place it over the I/O area, and install the chassis screws. The chassis screws will secure the I/O cover to the motherboard.

Installing the Motherboard

Installing the motherboard into a system case depends on several factors: if you are replacing an existing motherboard, building a new PC, and the chassis that will house your PC components. Determine if it would be easier to secure the motherboard to the chassis first or make connections to other components prior to this step. It is normally easier to secure the motherboard first.

Note: Be sure that the CPU fan assembly has enough clearance for the system case covers to lock into place and for the expansion cards. Also make sure the CPU Fan assembly is aligned with the vents on the covers. This will depend on the system case being used.

Securing the Motherboard into a System Case

Most system cases require installation of standoffs into the chassis to allow the motherboard to be mounted to the chassis and prevent short circuits. If there are studs that do not align with a mounting hole on the motherboard, it is recommended that you remove that standoff to prevent the possibility of a short circuit. Please review the installation manual included with your chassis for the proper installation of the motherboard standoffs.

1. Carefully place the motherboard onto the standoffs located inside the chassis.
2. Align the mounting holes with the standoffs.
3. Align the connectors to the I/O shield and/or I/O cover.
4. Ensure that the fan assembly is aligned with the chassis vents according to the fan assembly instruction.
5. Secure the motherboard with ten (10) screws. Ensure that each screw is lined up with and screwing into the corresponding standoff under the board. Double check alignment to make sure nothing gets cross-threaded.
6. See the picture below for a zoomed-in view of a hole to place over a standoff, as well as the locations of standoff holes for the X99 FTW-K.

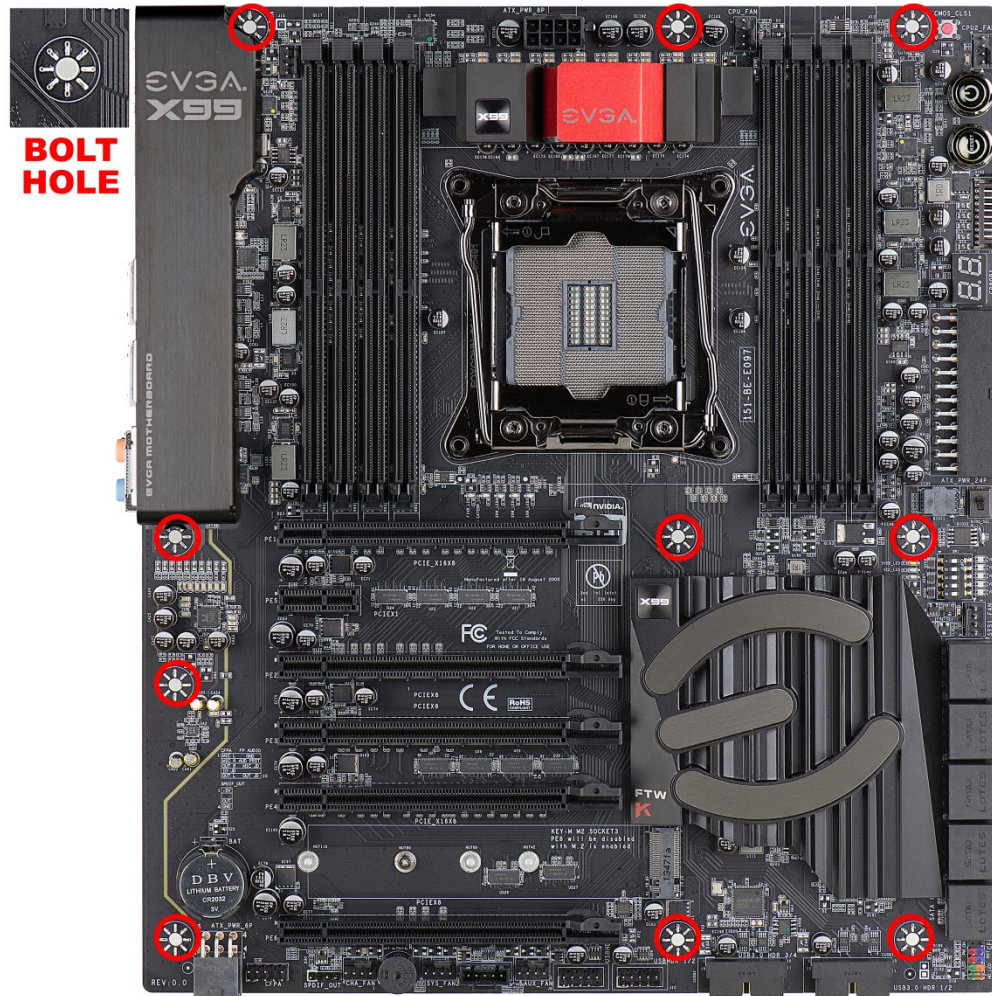

1. Above, all safe locations to secure the board to a standoff are circled in red.
2. Keep in mind that when the screws are installed but not fully tightened, the motherboard should have 1-2mm of movement; this can help with getting cards mounted or other tight tolerance/close fitting cards.

Connecting Cables

Important caveat: the images below do **NOT necessarily represent the physical orientation of the specific header on *your* motherboard. Rather, these are physical representations designed to give you a basic footprint of the component **AND** the cable pinouts for the ports.**

The location of these headers can be found on the component legend on page 12.

This section takes you through all the necessary connections on the motherboard. This will include:

- ❑ Power Connections
 - 24pin ATX power (**PW1**)
 - EPS 8pin 12V power
- ❑ Internal Headers
 - Front Panel connectors (power/reset/LED's)
 - Fan Headers (PWM for CPU and DC for case fans)
 - USB 2.0 Header
 - USB 3.0 Header
 - Audio Header
 - SATA III
- ❑ Rear I/O Panel

24pin ATX Power (ATX_PWR_24P)

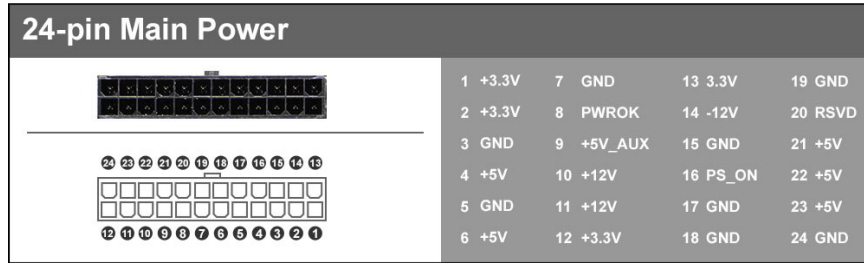

ATX_PWR_24p is the main power supply connector located along the lower-right edge of the board. Make sure that the power supply cable and pins are properly aligned with the connector on the motherboard. Firmly plug the power supply cable into the connector and make sure it is secure.

The 24pin Power Connector may be standard or right-angled depending on your motherboard model.

EPS 8-pin 12V Power (PWR 8P)

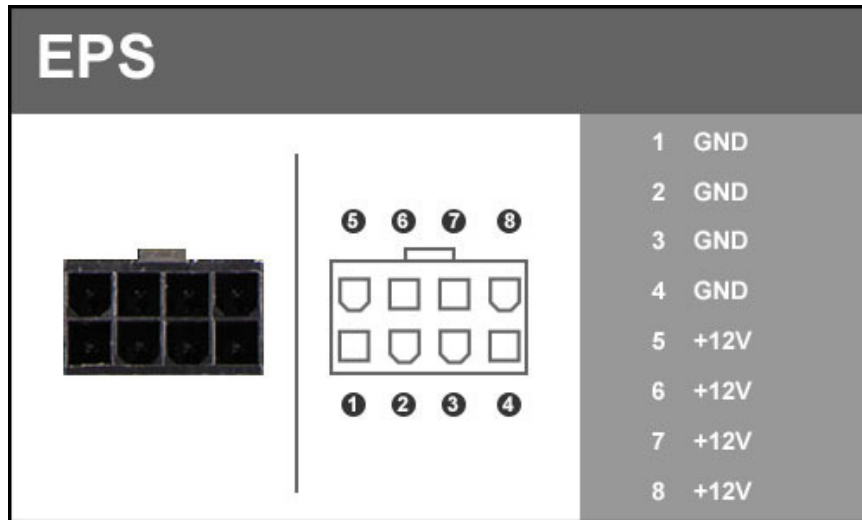

EPS PWR 8P, the 8-pin ATX 12V power connections, is used to provide power to the CPU. Align the pins to the connector and press firmly until seated. The secondary is optional for improved overclocking. Please remember to make sure that the tab on the EPS socket is aligned with the release clip on the cable. **NOTE:** If the tab and release clip are on opposite sides, yet the power connector fits, then you are using a PCI-E 8pin cable, which **WILL** damage the board if powered on. Please review installation instructions from your power supply manufacturer to verify which connectors may be used for the CPU power.

Front Panel Header

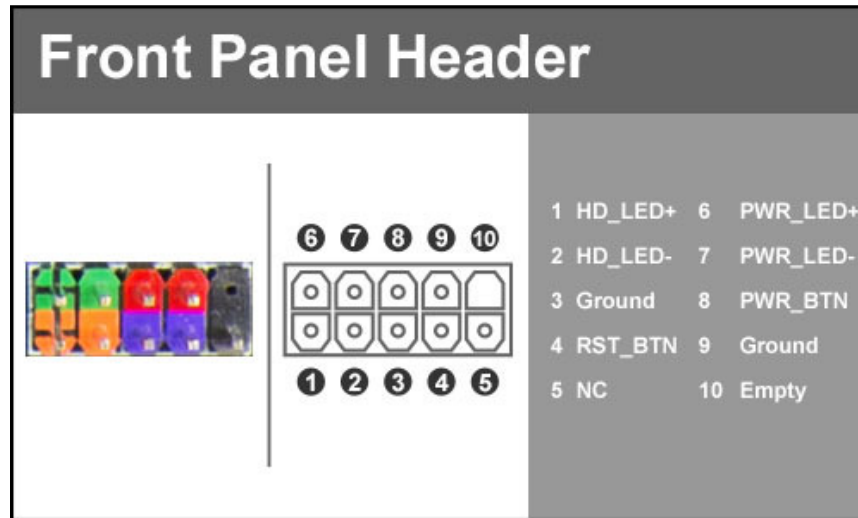

The front panel header on this motherboard is used to connect the following four cables.

- ❑ **PWRLED**
Attach the front panel power LED cable to these two pins of the connector. The Power LED indicates the system's status. When the system is powered on, the LED will be on.
- ❑ **PWRSW**
Attach the power button cable from the case to these two pins. Pressing the power button on the front panel turns the system on and off rather than using the onboard button.
- ❑ **HD_LED**
Attach the hard disk drive indicator LED cable to these two pins. The HDD indicator LED indicates the activity status of the hard disks.
- ❑ **RESET**
Attach the Reset switch cable from the front panel of the case to these two pins.

Note: Some system cases may not have all four cables. Be sure to match the name on the connectors to the corresponding pins.

Fan Header

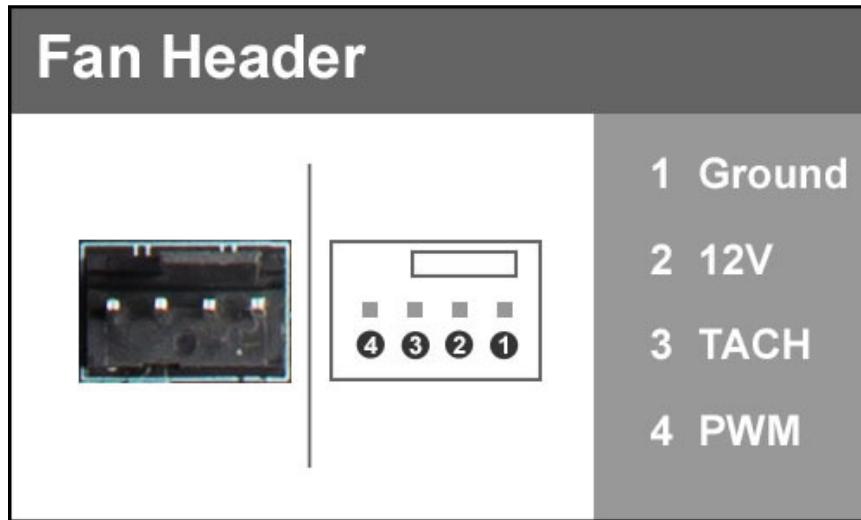

This motherboard line only has 4-pin fan headers, which are backwards compatible with 3-pin fan connectors. Fans may be controlled by PWM or DC controls. The headers have an absolute safe power limit of 1 Amp @ 12 Volts (12 Watts). These headers are for your CPU heatsink and chassis cooling fans.

USB Headers

This motherboard contains USB 3.1, 3.0, and 2.0 ports that are exposed on the rear panel of the chassis.

The motherboard contains 19-pin internal header connectors onboard that can be used to connect an optional external bracket containing up to (4) USB 3.0 ports.

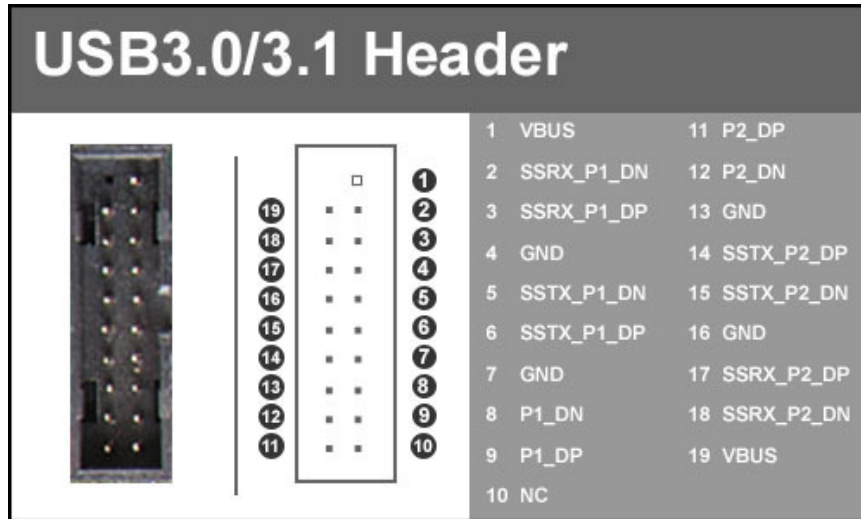

- ❑ Secure the bracket to either the front or rear panel of your chassis (not all chassis are equipped with the front panel option).
- ❑ Connect the end(s) of the cables to the USB 3.0 or 3.1 headers on the motherboard.

The motherboard contains 2x 9-pin internal header connectors onboard that can be used to connect an optional external bracket containing up to (4) USB 2.0 ports.

USB 2.0 Header



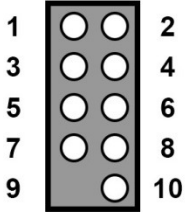

Pin	Signal
1	5V_Dual
3	D-
5	D+
7	GND
9	Empty
2	5V_Dual
4	D-
6	D+
8	GND
10	No Connect

- ❑ Secure the bracket to either the front or rear panel of your chassis (not all chassis are equipped with the front panel option).
- ❑ Connect the end(s) of the cables to the USB 2.0 headers on the motherboard.

Front Panel Audio Header

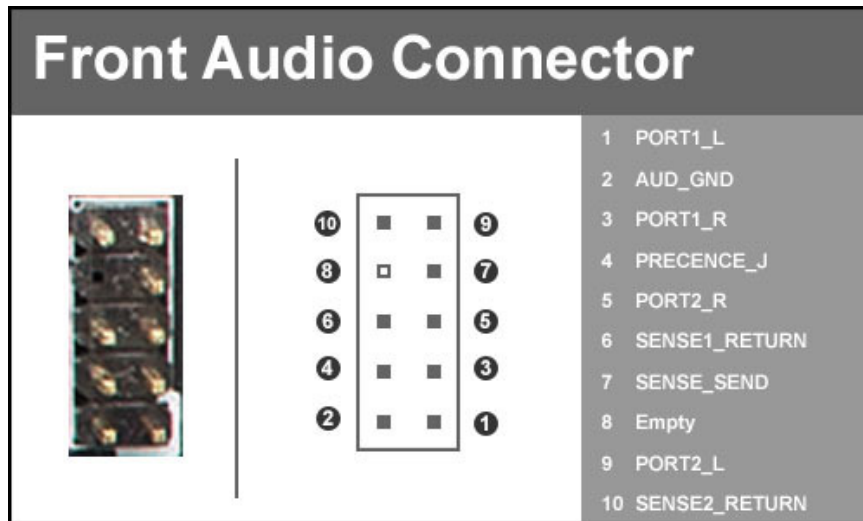

The audio connector supports HD audio standard and provides two kinds of audio output choices: the Front Audio and the Rear Audio.

S/PDIF Header

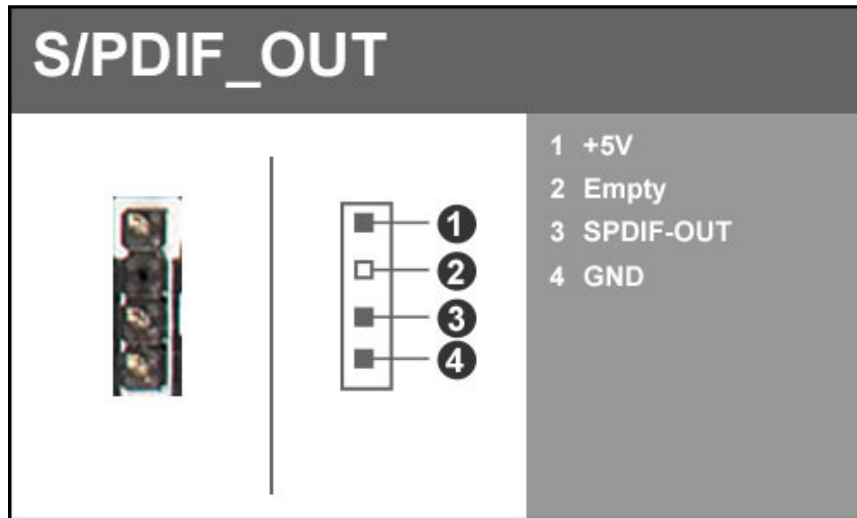

The S/PDIF (Sony/Philips Digital Interface Format) is used for specific Audio-Out applications, typically for using an audio pass-through device.

Thunderbolt GPIO Header

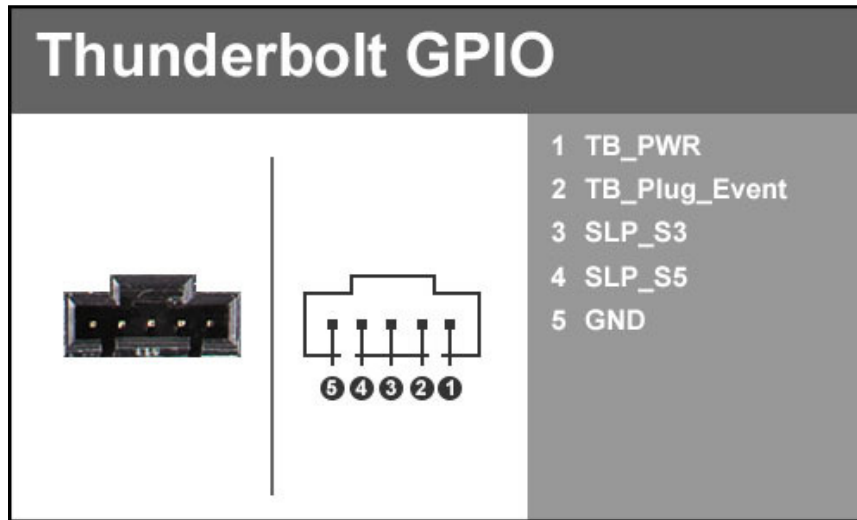

Thunderbolt technology is a transformational high-speed and dual protocol PC I/O that delivers performance, simplicity and flexibility. Thunderbolt I/O technology allows you to move data between your devices and your computer on 2 channels with speeds of up to 20Gbps flowing both ways (upstream and downstream) simultaneously. You to connect as many as 6 devices, daisy-chained, through a single compact port.

Probe IT Header

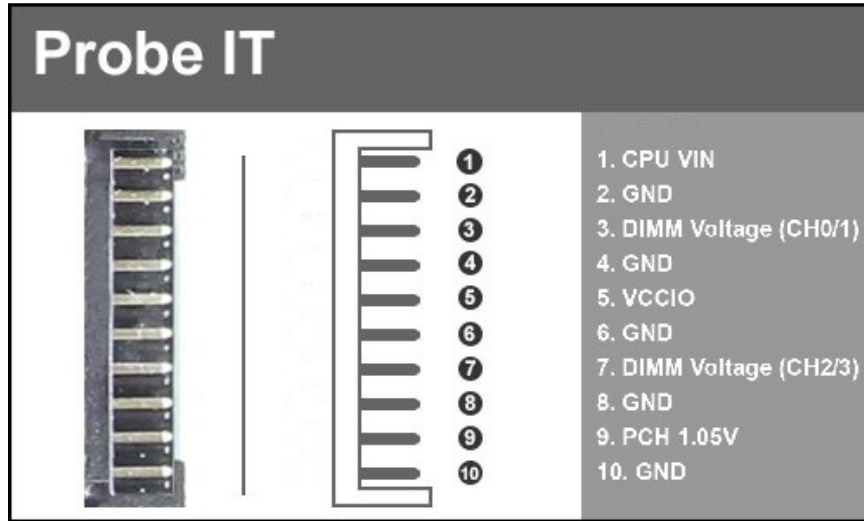

The Probe IT offers a means of monitoring several different voltages under any level of load with a digital multi-meter so you can see exactly what voltages your board is pushing. This is mainly used for extreme overclocking.

6pin PCI-E

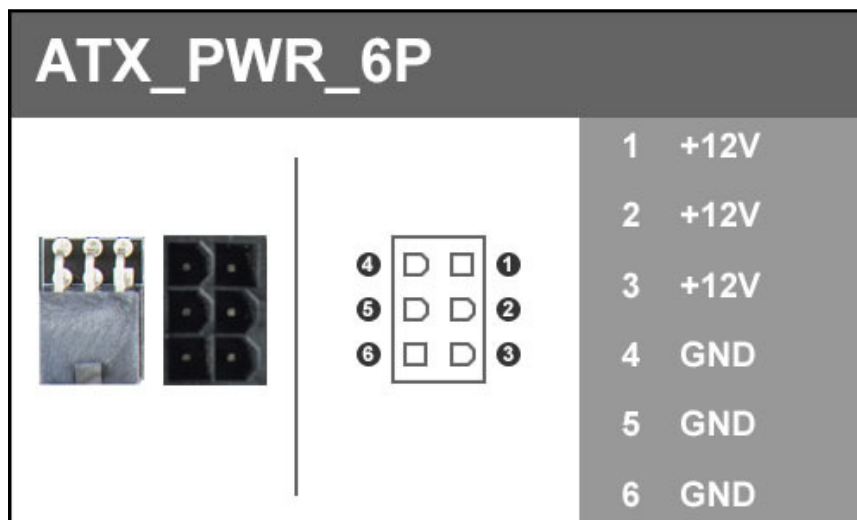

The 6pin PCI-E connector present on the motherboard provides additional power to the PCI-E slots, rather than pulling it all from the 24-pin main power. It is advised to plug in this connector when using SLI, especially with higher-end graphic cards. It is strongly recommended to plug in this connector for 3-way and 4-way SLI, regardless of GPU.

SATA 3/6G Headers

SATA3/6G is the current standard for HDD/SSD/Optical interface. These cables are the data interconnect for the motherboard. Your HDD/SSD/Optical interface will still require a separate power connection from your power supply.



SATA RAID ports support RAID functions 0, 1, 5, and 10 through the native Intel controller. RAID-ready ports also have full AHCI functionality and are boxed above in RED.

SATA AHCI ports only support AHCI functions, which include Hotswap (provided it is enabled and you have Hotswap capable hardware attached), NCQ, and are backwards-compatible with previous SATA standards.

Onboard Buttons

These onboard buttons include RESET, POWER and Clear CMOS. These functions allow you to easily reset the system, turn on/off the system, or clear the CMOS.

Clear CMOS Button

The motherboard uses CMOS RAM to store set parameters. The CMOS may be cleared by pressing the Clear CMOS button on the motherboard PCB or on the external I/O Panel.

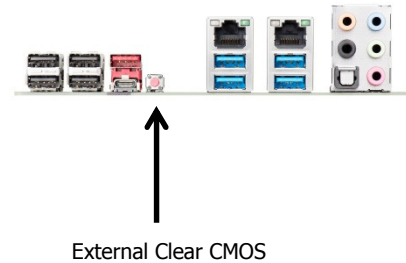

RESET and POWER Button

These onboard buttons allow you to easily turn on/off the system. These buttons allow for easy debugging and testing of the system during troubleshooting situations.

The POWER button has an integrated LED, indicating the system's status. When the system is powered on, the LED remains a solid red.

The RESET button has an integrated LED, indicating the activity status of the hard disk drives and will flicker accordingly.



↑
Power
Button

↑
Reset
Button

Installing Drivers and Software

Note: It is important to remember that before installing the driver CD that is shipped in the kit, you must first load or install your operating system. The motherboard supports 32bit and 64bit versions of Windows 10, 8, and 7.

The kit comes with a CD that contains utilities, drivers, and additional software.

The CD that has been shipped with the EVGA X99 Motherboard contains the following software and drivers:

- ❑ Chipset Drivers
- ❑ Audio Drivers
- ❑ RAID Drivers
- ❑ LAN Drivers
- ❑ USB 3.0 Drivers
- ❑ ME Drivers
- ❑ SATA Drivers
- ❑ EVGA E-LEET X
- ❑ User's Manual

Windows 10/8/7 Driver Installation

1. Insert the EVGA X99 installation CD for the motherboard included in the kit.
2. The CD will autorun. Install the drivers and utilities listed on the install screen. If the CD does not run, go to My Computer and click on the CD to open.

Have a question, or want some online resources?

If you have any issues or questions, you can find a lot of valuable help and information on our website, including contact information for our 24/7 US Technical Support/Customer Service.

- You may find all of the motherboard drivers at <http://www.evga.com/support/download/>. Select the “Motherboard” tab, then select “Intel X99” from the Family tab, then “151-BE-E097” from the part number pulldown, then either “All” or the specific component you are concerned with, and you operating system and click “Submit”
- You may find the list of officially supported CPU’s and System RAM for your motherboard, including the minimum required BIOS revision for compatibility, at: <http://www.evga.com/support/motherboard/>. BIOS updates are inclusive, so they will always support the products from the previous version, except when specified otherwise.
- For our Frequently Asked Questions (FAQ) database, go to: <http://www.evga.com/support/knowledgebase/>
- To visit our Community Forums, go to: <http://forums.evga.com/>
- For our Community Forums section dedicated to X99 motherboards, go to: <http://forums.evga.com/EVGA-X99-Series-f98.aspx>
- Just finished building or upgrading your system and want to show it off? Make a ModsRigs Profile here: <http://www.modsrigs.com/> and create a page dedicated entirely to YOUR system!
- Still building your rig? Make a build log here: <http://forums.evga.com/EVGA-MODS-RIGS-f33.aspx>
- Want to join the online EVGA Gaming Community? Sign up and play with like-minded gamers here: <http://www.evga.com/TEAMEVGA/>

Post Port Debug LED

Provides two-digit diagnostic POST codes which shows system boot status and can also show why the system may be failing to boot. It is very useful during troubleshooting situations.

This Debug LED will display a series of hexadecimal (0-F) codes during the POST and upon a successful boot, will display current CPU socket temperatures after the system has fully booted into the Operating System. See the “POST CODE” section below for more detailed descriptions of specific POST Codes.



Debug LED with CPU
Temperature Monitor

POST Codes

This section provides the AMI POST Codes for the EVGA X99 FTW-K Motherboard during system boot up.

The POST Codes are displayed on the Debug LED readout located directly onboard the motherboard.

This Debug LED will also display current CPU temperatures after the system has fully booted into the Operating System.



Debug LED with CPU Temperature Monitor

AMI POST Codes

01	Power on. Reset type detection (soft/hard).
02	AP initialization before microcode loading
03	North Bridge initialization before microcode loading
04	South Bridge initialization before microcode loading
05	OEM initialization before microcode loading
06	Microcode loading
07	AP initialization after microcode loading
08	North Bridge initialization after microcode loading
09	South Bridge initialization after microcode loading
0A	OEM initialization after microcode loading
0B	Cache initialization
0C-0D	Reserved for future AMI SEC error codes
0E	Microcode not found
0F	Microcode not loaded
10	PEI Core is started
11-14	Pre-memory CPU initialization is started
15-	Pre-memory North Bridge initialization is started

18	
19-1C	Pre-memory South Bridge initialization is started
1D-2A	OEM pre-memory initialization codes
2B	Memory initialization. Serial Presence Detect (SPD) data reading
2C	Memory initialization. Memory presence detection
2D	Memory initialization. Programming memory timing information
2E	Memory initialization. Configuring memory
2F	Memory initialization (other).
30	Reserved for ASL (see ASL Status Codes section below)
31	Memory Installed
32	CPU post-memory initialization is started
33	CPU post-memory initialization. Cache initialization
34	CPU post-memory initialization. Application Processor(s) (AP) initialization
35	CPU post-memory initialization. Boot Strap Processor (BSP) selection
36	CPU post-memory initialization. System Management Mode (SMM) initialization
37-3A	Post-Memory North Bridge initialization is started
3B-3E	Post-Memory South Bridge initialization is started
3F-4E	OEM post memory initialization codes
4F	DXE IPL is started
50	Memory initialization error. Invalid memory type or incompatible memory speed
51	Memory initialization error. SPD reading has failed
52	Memory initialization error. Invalid memory size or memory modules do not match.
53	Memory initialization error. No usable memory detected
54	Unspecified memory initialization error.
55	Memory not installed
56	Invalid CPU type or Speed
57	CPU mismatch
58	CPU self-test failed or possible CPU cache error
59	CPU micro-code is not found or micro-code update is failed
5A	Internal CPU error
5B	reset PPI is not available
5C-	Reserved for future AMI error codes

5F	
E0	S3 Resume is started (S3 Resume PPI is called by the DXE IPL)
E1	S3 Boot Script execution
E2	Video repost
E3	OS S3 wake vector call
E4- E7	Reserved for future AMI progress codes
E8- EB	S3 Resume Failed
EC- EF	Reserved for future AMI error codes
F0	Recovery condition triggered by firmware (Auto recovery)
F1	Recovery condition triggered by user (Forced recovery)
F2	Recovery process started
F3	Recovery firmware image is found
F4	Recovery firmware image is loaded
F5- F7	Reserved for future AMI progress codes
F8	Recovery PPI is not available
F9	Recovery capsule is not found
FA	Invalid recovery capsule
FB- FF	Reserved for future AMI error codes
60	DXE Core is started
61	NVRAM initialization
62	Installation of the South Bridge Runtime Services
63- 67	CPU DXE initialization is started
68	PCI host bridge initialization
69	North Bridge DXE initialization is started
6A	North Bridge DXE SMM initialization is started
6B- 6F	North Bridge DXE initialization (North Bridge module specific)
70	South Bridge DXE initialization is started
71	South Bridge DXE SMM initialization is started
72	South Bridge devices initialization
73- 77	South Bridge DXE Initialization (South Bridge module specific)
78	ACPI module initialization
79	CSM initialization

7A– 7F	Reserved for future AMI DXE codes
80– 8F	OEM DXE initialization codes
90	Boot Device Selection (BDS) phase is started
91	Driver connecting is started
92	PCI Bus initialization is started
93	PCI Bus Hot Plug Controller Initialization
94	PCI Bus Enumeration
95	PCI Bus Request Resources
96	PCI Bus Assign Resources
97	Console Output devices connect
98	Console input devices connect
99	Super IO Initialization
9A	USB initialization is started
9B	USB Reset
9C	USB Detect
9D	USB Enable
9E– 9F	Reserved for future AMI codes
A0	IDE initialization is started
A1	IDE Reset
A2	IDE Detect
A3	IDE Enable
A4	SCSI initialization is started
A5	SCSI Reset
A6	SCSI Detect
A7	SCSI Enable
A8	Setup Verifying Password
A9	Start of Setup
AA	Reserved for ASL (see ASL Status Codes section below)
AB	Setup Input Wait
AC	Reserved for ASL (see ASL Status Codes section below)
AD	Ready To Boot event
AE	Legacy Boot event
AF	Exit Boot Services event
B0	CPU Memory controller configuration
B1	Runtime Set Virtual Address MAP End
B2	iMC init
B3	Memory training

B4	Memory training
B5	Memory training / timing training
B6	Memory training
B7	Memory training
B8- BF	Memory training / DRAM final configuration
C0- CF	OEM BDS initialization codes
D0	CPU initialization error
D1	North Bridge initialization error
D2	South Bridge initialization error
D3	Some of the Architectural Protocols are not available
D4	PCI resource allocation error. Out of Resources
D5	No Space for Legacy Option ROM
D6	No Console Output Devices are found
D7	No Console Input Devices are found
D8	Invalid password
D9	Error loading Boot Option (Load Image returned error)
DA	Boot Option is failed (Start Image returned error)

EVGA Glossary of Terms

AC – Alternating Current

ACPI - Advanced Configuration and Power Interface

AHCI – Advanced Host Controller Interface

AFR – Alternate Frame Rendering

APIC - Advanced Programmable Interrupt Controller

BCLK – Base Clock (or operating frequency of base system bus)

BIOS - Basic Input Output System

CMOS - Complementary Metal-Oxide Semiconductor

CPU – Central Processing Unit

DC – Direct Current

DDR - Double Data Rate

DIMM - Dual In-line Memory Module

DMI – Direct Memory Interface

DRAM - Dynamic random access memory

DVI – Digital Video Interface

ELEET/ELEET X – EVGA motherboard monitoring and tuning software

GHz – Gigahertz

GPU – Graphics Processing Unit

HDD - Hard Disk Drive

HDMI - High-Definition Multimedia Interface

HDR – High Dynamic Range Lighting

HPET - High Precision Event Timer

HT – Hyper-Threading

HSF - Heat Sink Fan

I/O - Input/ Output

IEEE - Institute of Electrical and Electronics Engineers

IGP - Integrated Graphics Processors

IMC – Integrated memory controller
IRQ - Interrupt Request
JBOD - Just a Bunch of Disks
JEDEC - Joint Electron Device Engineering Council
LAN - Local Area Network
LCD - Liquid Crystal Display
LGA – Land Grid Array
LN2 – Liquid Nitrogen Cooling
MAC - Media Access Control
MCP - Media and Communications Processor
Intel ME – Intel Management Engine
MHz – Megahertz
MMIO – Memory Mapped I/O
NB - Northbridge
NCQ - Native Command Queuing
NIC - Network Interface Card
NTFS - New Technology File System
NVMe – Non-Volatile Memory Express
OEM - Original Equipment Manufacturer
PATA - Parallel Advanced Technology Attachment
PCB - Printed Circuit Board
PCH – Platform Controller Hub
PCI - Peripheral Component Interconnect
PCI-E - Peripheral Component Interconnect Express
PLL – Phase Locked Loop
POST – Power on Self-Test
PWM – Pulse Width Modulation
QDR - Quad Data Rate
QPI – Quick Path Interconnect

RAID - Redundant Array of Inexpensive Disks
RAM – Random Access Memory
ROM – Read Only Memory
RGB - Red Green Blue
SATA - Serial Advanced Technology Attachment
SAS – Serial Attached SCSI
SB - Southbridge
SCSI - Small Computer System Interface
SFR – Split Frame Rendering
SLI - Scalable Link Interface
SPD - Serial Presence Detect
S/PDIF - Sony/Philips Digital Interconnect Format
SPP - System Platform Processors
SSD – Solid State Drive
TCP/IP - Transmission Control Protocol/Internet Protocol
USB - Universal Serial Bus
VDroop - Voltage Droop
VGA - Video Graphics Array
VREG – Voltage Regulator

Compliance Information

FCC Compliance Information

This device complies with FCC Rules Part 15. Operation is subject to the following two conditions: (1) This device may not cause harmful interference, and (2) this device must accept any interference received, including interference that may cause undesired operation. This equipment has been tested and found to comply with the limits for a Class B digital device, pursuant to Part 15 of the FCC Rules. These limits are designed to provide reasonable protection against harmful interference in a residential installation. This equipment generates, uses and can radiate radio frequency energy and, if not installed and used in accordance with the manufacturer's instructions, may cause harmful interference to radio communications. However, there is no guarantee that interference will not occur in a particular installation. If this equipment does cause harmful interference to radio or television reception, which can be determined by turning the equipment off and on, the user is encouraged to try to correct the interference by one or more of the following measures: (1) Increase the separation between the equipment and signal source, or (2) connect the equipment to an outlet on a circuit different from that to which the signal source is connected. Consult the dealer or an experienced computer technician for help. The use of shielded cables for connection of peripheral devices to the PC systems is required to ensure compliance with FCC regulations. Changes or modifications to this unit not expressly approved by the party responsible for compliance could void the user's authority to operate the equipment.

CE Compliance Information

Generic Radiation Interference Standard for Information Technology Equipment. (EN 55022: 2006, Class B), (EN 61000-3-2: 2006), (EN 61000-3-3: 1995 + A1: 2001 + A2: 2005). Warning: This is a Class B product. In a domestic environment this product may cause radio interference in which case the user may be required to take adequate measure. Generic Immunity Standard for Information Technology Equipment. (EN 55024: 1998 + A1: 2001 + A2: 2003).

Trademark & Copyright Information

2001-2016 EVGA Corp. EVGA, the EVGA logo and combinations thereof are trademarks of EVGA Corp. All brand names, company names, service marks, logos, and trademarks of the company, or its affiliates or licensors are trademarks or registered trademarks of the company or its subsidiaries, affiliates or licensors in the US and other countries. Other company, products and service names may be trademarks or service marks of others. EVGA reserves the right to terminate this license if there is a violation of its terms or default by the Original Purchaser. Upon termination, for any reason, all copies of Software and materials must be immediately returned to EVGA and the Original Purchaser shall be liable to EVGA.com CORP for any and all damages suffered as a result of the violation or default.

Legal Information

All material including but not limited to, text, data, design specifications, diagnostics, graphics, logos, reference boards, files, images, drawings, and software including this document and the software itself (together and separately) is owned, controlled by, licensed to, or used with permission by EVGA Corporation and is protected by copyright, trademark, and other intellectual property rights. All is being provided "as is", EVGA Corporation makes no warranties, whether express or implied, statutory or otherwise with respect to the materials and expressly disclaims all implied warranties of non-infringement, merchantability, and fitness for a particular purpose. In no event shall the liability of EVGA Corporation for claims arising from the use of the materials by anyone exceed the original purchase price of the materials (or replacement of the materials at EVGA Corporation's option). All information furnished is believed to be accurate and reliable. However, EVGA Corporation assumes no responsibility for the consequences of use of such information or for any infringement of patents or other rights of third parties that may result from its use, or use of the Software. No license is granted by implication or otherwise under any patent or patent rights of EVGA Corporation except as expressly provided herein. All specifications mentioned in this publication are subject to change without notice.

Ver. 2